

ARGOX

a  company

Compact Printer series

User's Manual

CP-EX Series / CX Series



Version: 1.9

service@argox.com

Website: <http://www.argox.com>

Media



Ribbon



[Installation Video]

Table of Contents

Introduction	1
Proprietary Statement	1
Product Improvements	1
FCC Compliance Statement.....	1
Liability Disclaimer.....	2
Getting Started	3
Unpacking Printer.....	3
Package Contents	4
Printer Overview	5
Front View:	5
Rear View: CP-2140EX / CP-3140EX / CX series ...	6
Interior View I	7
Interior View II	8
Attaching Power	9
Loading Media.....	10
Preparing Media.....	10
Placing Media Roll	10
Media Sensor Type Setting	15
Multi-Column Label Setting by Software/ Driver....	15
Loading Ribbon	16
Preparing Ribbon	16
Placing Ribbon Rolls.....	17
Printer Operation	22
Printing Media Calibration & Configuration.....	22
Steps to Start Media Calibration & Configuration ...	22
Sample of Printer Configuration Label	23
Resetting Printer to Factory Defaults.....	24
Printer Controls and Indicators.....	25
Troubleshooting by LED Indicators Diagnosis.....	28

Miscellaneous	31
Recovery.....	32
Communications	33
Interfaces and Requirements	33
USB Interface Requirements	33
Serial (RS-232) Interface Requirements.....	34
Serial and Parallel Cabling Requirements	34
Ethernet 10/100 Internal Printer Server Option.....	34
Ethernet Status Indicators	35
Communicating with the Printer	36
Installing a Plug and Play printer driver (for USB only)	36
Installing a Printer Driver (for other interfaces except USB).....	42
Caring for Your Printer.....	48
Print Head Maintenance Guide	48
Cleaning Interval.....	48
Cleaning Material.....	48
Cleaning Direction	49
Configuring Your LAN Printer by Web Setting Tool	50
Attaching the power cord	50
Connecting your LAN printer to a LAN hub.....	50
Getting the IP address of your LAN printer	51
Logging in to the web setting tool	51
Product Specification	53
General Specification	53
Fonts, Barcodes, and Graphics Specification	55
Printer Programming Language PPLA.....	55
Printer Programming Language PPLB.....	56
Printer Programming Language PPLZ.....	57
Interface Specification.....	58

USB Interface.....	58
Ethernet Interface.....	59
Serial Interface	60
Dimensions	63

Introduction

Proprietary Statement

This manual contains proprietary information of Argox Information Co., Ltd. It is intended solely for the information and use of parties operating and maintaining the equipment described herein. Such proprietary information may not be used, reproduced, or disclosed to any other parties for any other purpose without the expressed written permission of Argox Information Co., Ltd.

Product Improvements

Continuous improvement of products is a policy of Argox Information Co., Ltd. All specifications and signs are subject to change without notice.

FCC Compliance Statement

This equipment has been tested and found to comply with the limits for a Class A digital device, pursuant to Part 15 of the FCC Rules. These limits are designed to provide reasonable protection against harmful interference in a residential installation. This equipment generates, uses, and can radiate radio frequency energy and, if not installed and used in accordance with the instructions, may cause harmful interference to radio communications. However, there is no guarantee that the interference will not occur in a particular installation. If this equipment does cause harmful interference to radio or television reception, which can be determined by turning the equipment off and on, the user is encouraged to try to correct the interference by the following measures:

- Reorient or relocate the receiving antenna.
- Increase the separation between the equipment and the receiver.
- Connect the equipment into a different outlet on a different circuit.
- Consult the dealer or an experience Radio/TV technician for help.

This unit was tested with shielded cables on the peripheral devices. Shielded cables must be used with the unit to insure compliance. The user is cautioned that any changes or modifications not expressly approved by Argox Information Co., Ltd. could void the user's authority to operate the equipment.

Liability Disclaimer

Argox Information Co., Ltd. takes steps to assure that the company's published engineering specifications and manuals are correct; however, errors do occur. Argox Information Co., Ltd. reserves the right to correct any such errors and disclaims any resulting liability. In no event shall Argox Information Co., Ltd. or anyone else involved in the creation, production, or delivery of the accompanying product (including hardware and software) be liable for any damages whatsoever (including, without limitation, damages for loss of business profits, business interruption, loss of business information, or other pecuniary loss) arising out of the use of or the results of use of or inability to use such product, even if Argox Information Co., Ltd. has been advised of the possibility of such damages.

CAUTION:

Any changes or modifications not expressly approved by the party responsible for compliance could void the user's authority to operate the equipment.

To ensure this printer can fulfill user's demand, when using narrow media for continuous printing, the printer will optimize appropriately to support continuous, high quality print-out. If you have any questions, please consult Argox technical service personnel.



Getting Started

Congratulations on choosing CP-EX / CX compact printer series, made by Argox Information Co., a leader in the worldwide barcode industry. CP / CX compact printer series are ideally designed to easily bring more efficiency for your business. This manual will help you get to know your new printer and provide sufficient information needed.

Unpacking Printer

After receiving your printer, please check for possible shipping damage:

Inspect the outside of both the box and the printer for possible damage.

1. Open the top cover of the printer to see if all parts are in order.

Note: *If finding that the printer shipped is damaged, contact your shipping company immediately to file a claim.*

2. Check whether you have received the following accessories together with the printer. If there is any item missing, please contact your local dealer.

Package Contents

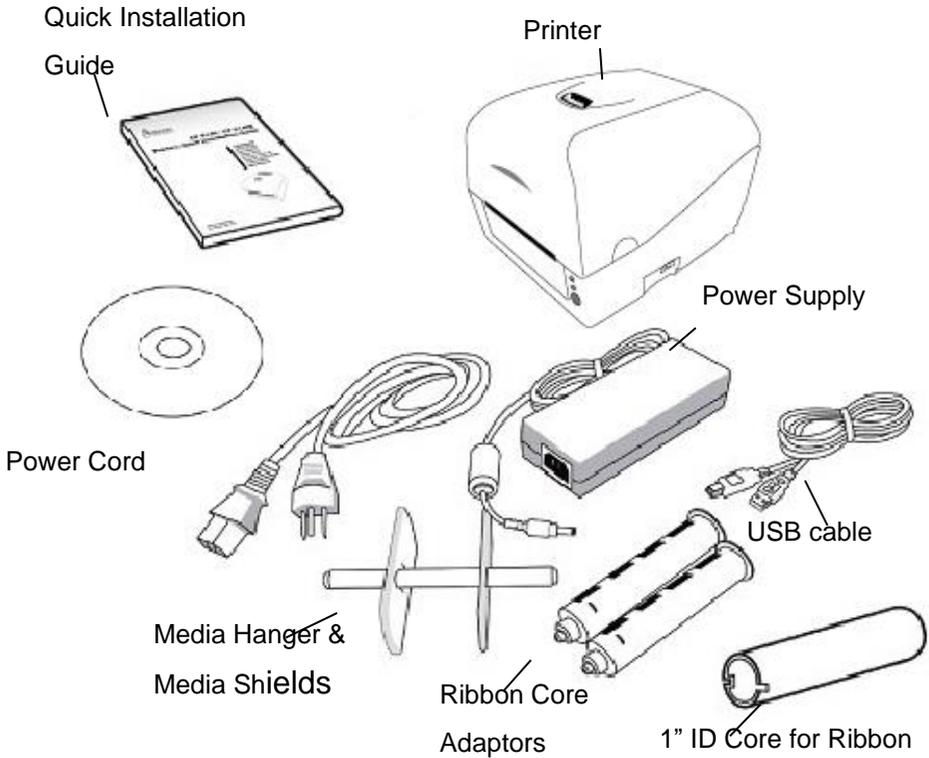

- Quick Installation Guide
- Power Cord
- Media Hanger & Media Shields
- Printer
- Power Supply
- USB cable
- Ribbon Core Adaptors
- 1" ID Core for Ribbon
- DVD

Printer Overview

Front View:

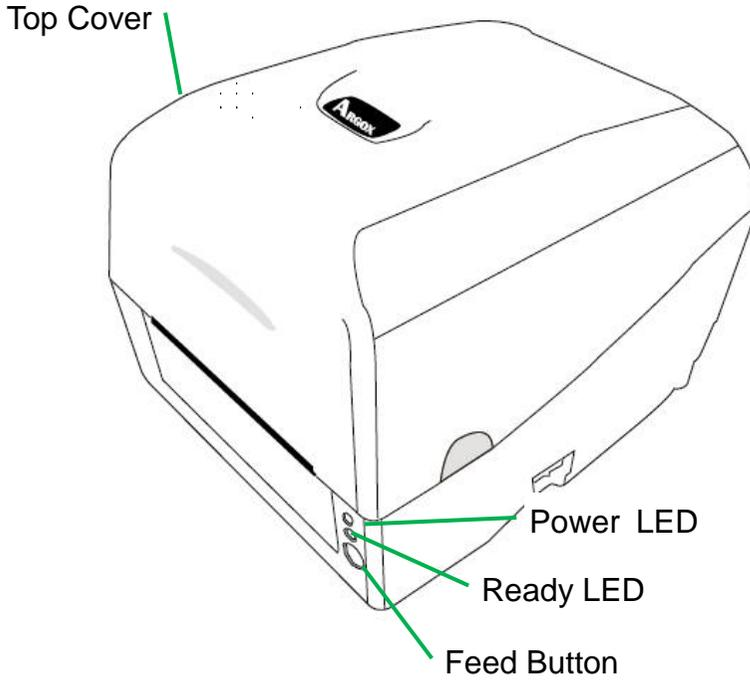

Rear View: CP-2140EX / CP-3140EX / CX series

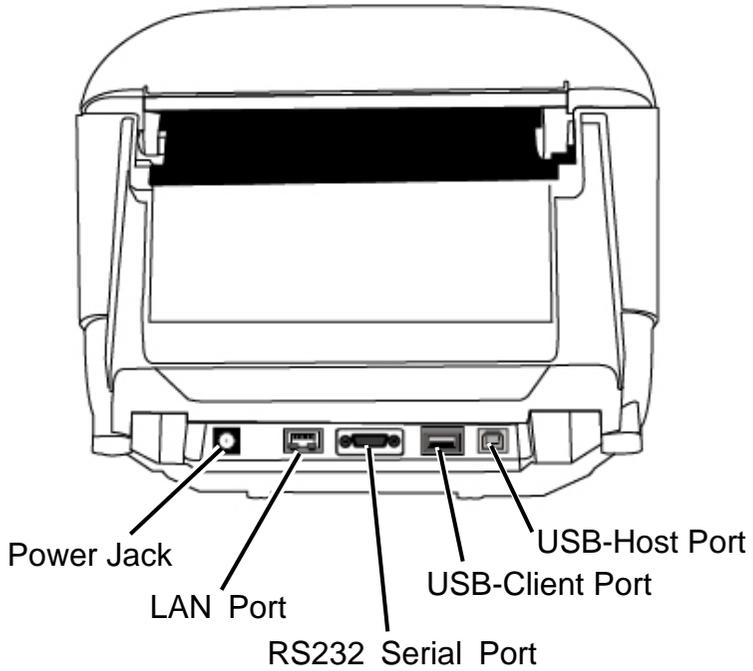

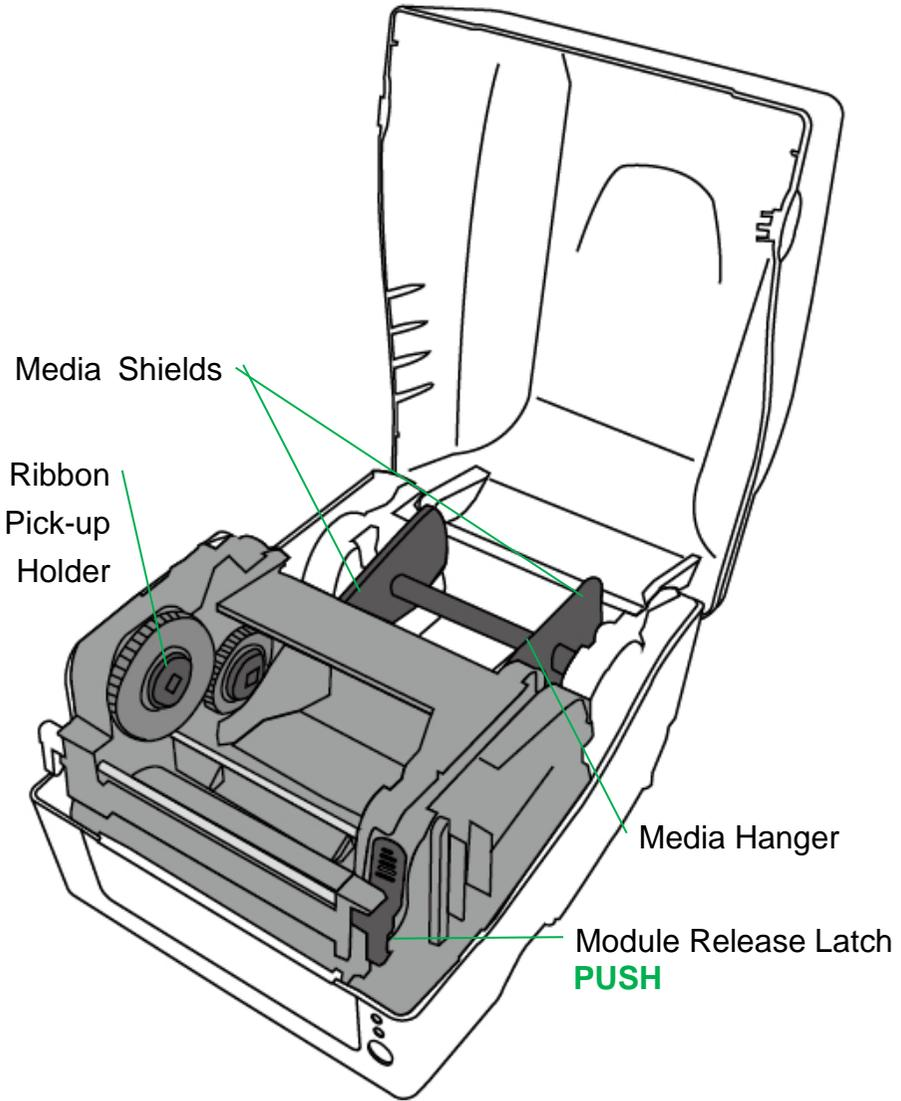

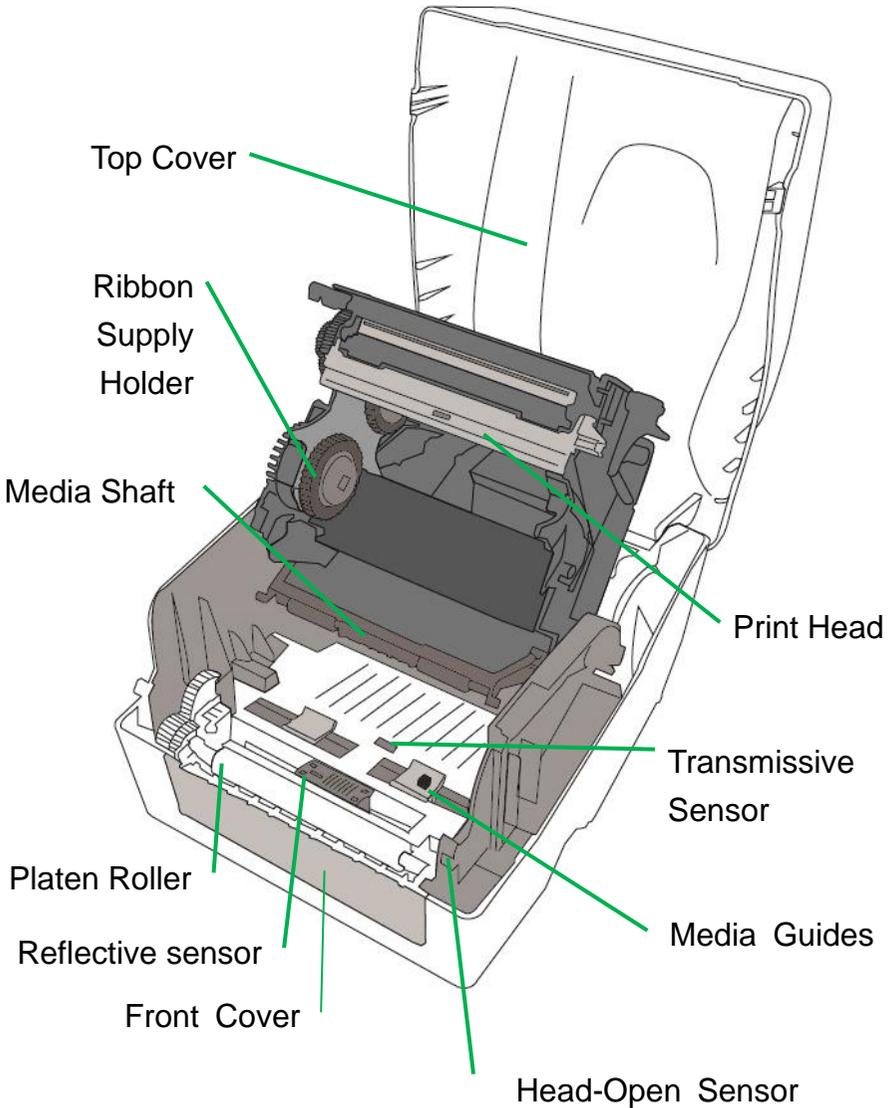

Printhead Replacement / Cleaning Video



Platen Roller Replacement / Cleaning Video

Attaching Power

1. Make sure the printer's power switch is in the off position (down).
2. Insert the AC power cord into the power supply.
3. Insert the power supply's power connector into the printer's power jack.
4. Plug the other end of the power cord into an appropriate grounded AC electrical outlet.

Warning:

Do not operate the printer and power supply in an area where they might get wet.

CP-2140EX, CP-3140EX, CX-2140

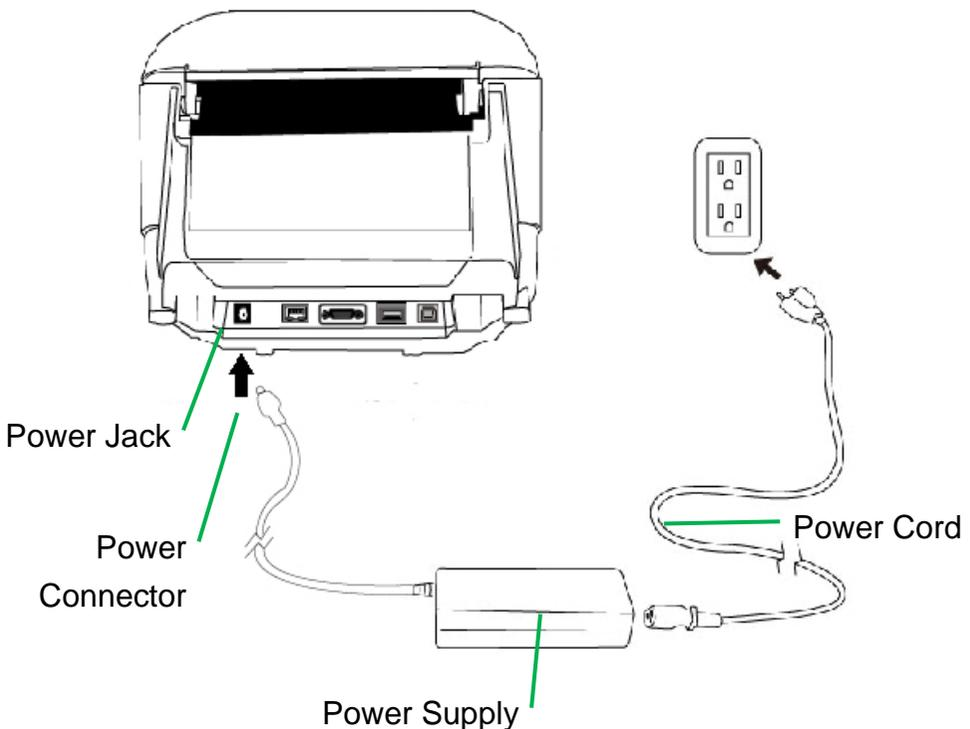

Loading Media

Preparing Media

The inside wound or outside wound media rolls can be loaded into the printer in the same way. In case media roll may become dirty or dusty during shipment, handling, or storage, firstly remove the outside length of media, which helps to avoid dragging adhesive or dirty media between the print head and platen roller. When loading media, it must be placed onto the media hangers.

Placing Media Roll

1. Gently press the recesses on both sides of the top cover of the printer (1), and then lift up the top cover of the printer to open (2).

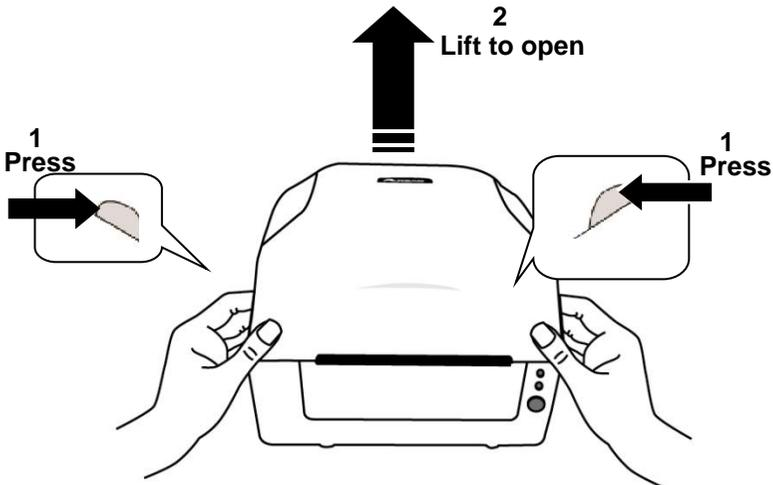

- Put the Media Hanger through media supply roll, and then centrally align with the two Media Shields to closely lean against the media supply roll.

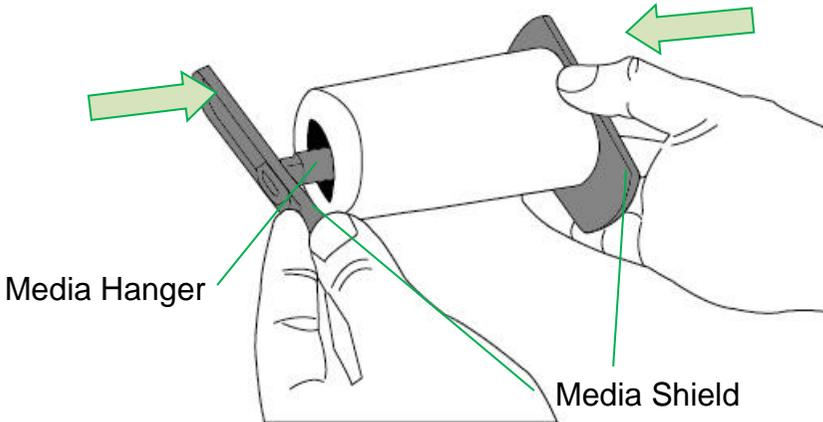

- Locate the media supply roll into the Media Compartment of printer.

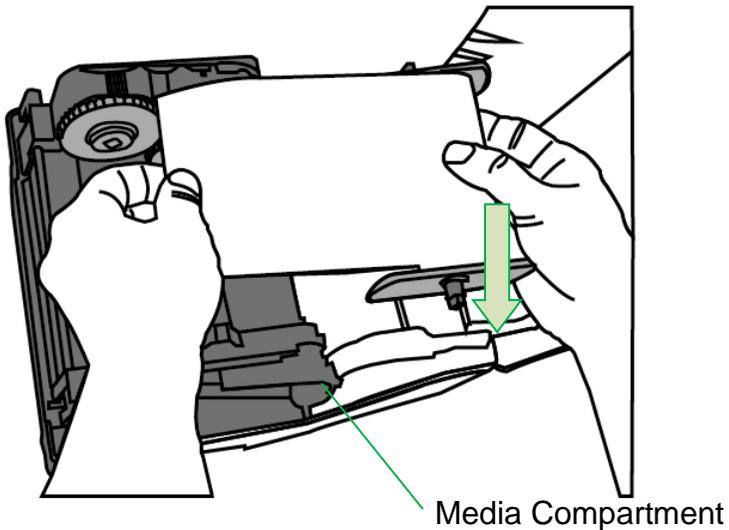

4. Push the Release Latch to open the printer module.

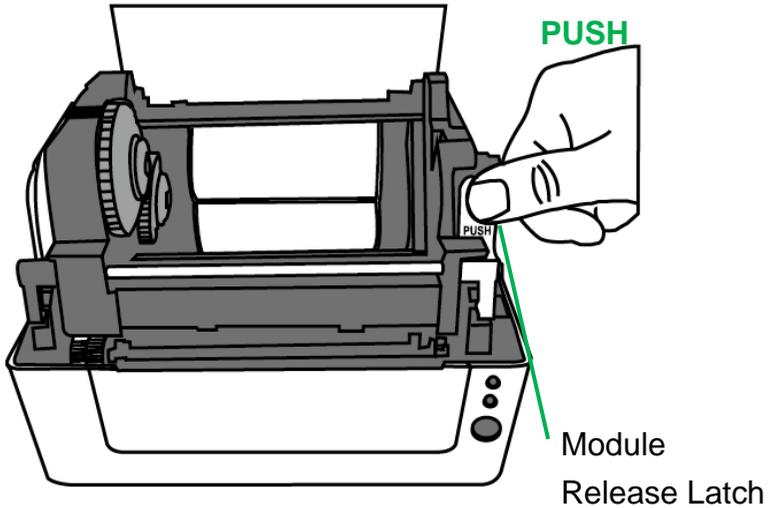

5. Pull a short length of media until it reaches the Platen Roll of printer.

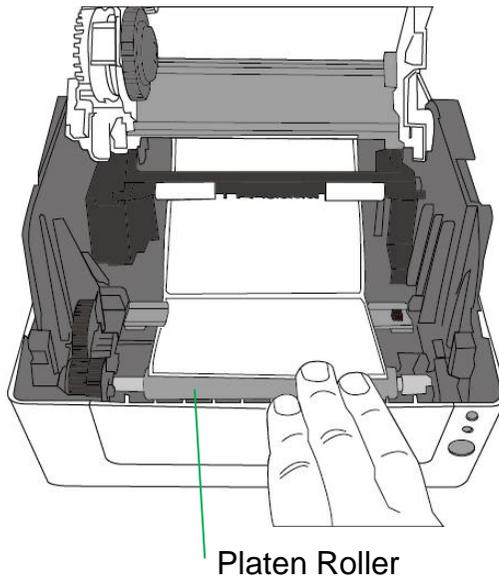

6. Press the lock of Media Guide at the right to adjust media guides' positions. Make sure media stays under the Media Shaft and centrally under both of the Media Guides.

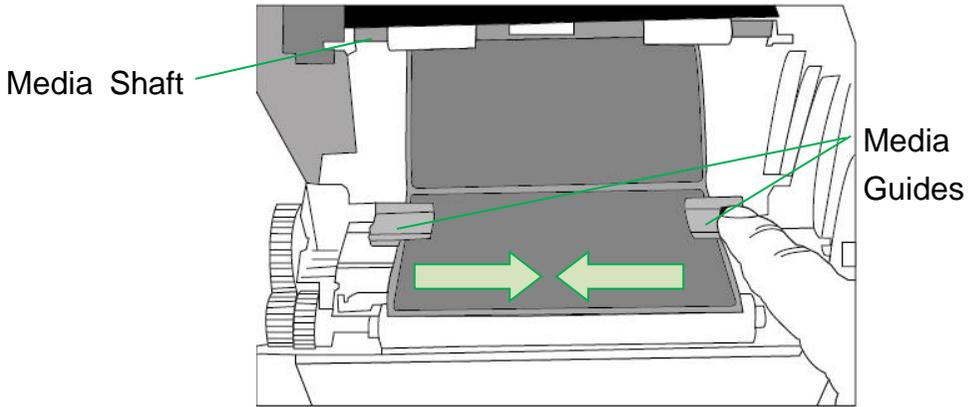

7. Close the printer module and then press firmly at the both sides to properly latch until you hear a click.

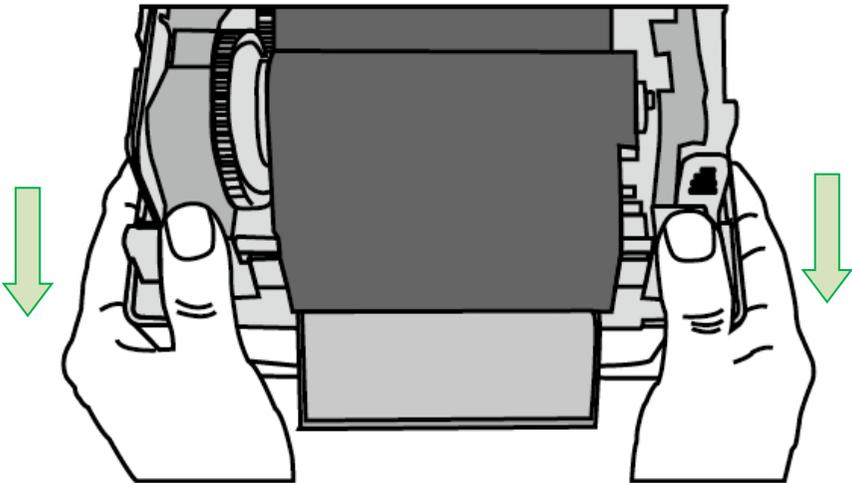

8. Press the FEED button to feed labels out of the printer.

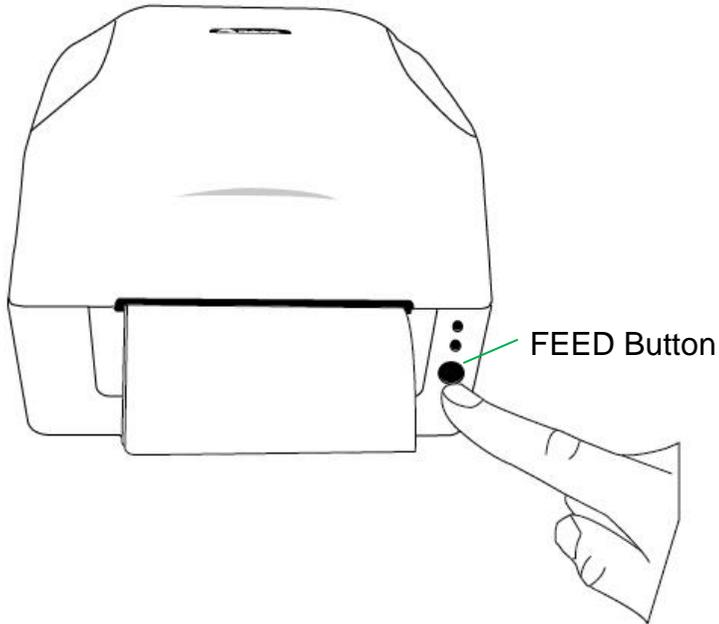

9. To tear media, pull the media edge against the Tear Bar as in the direction below:

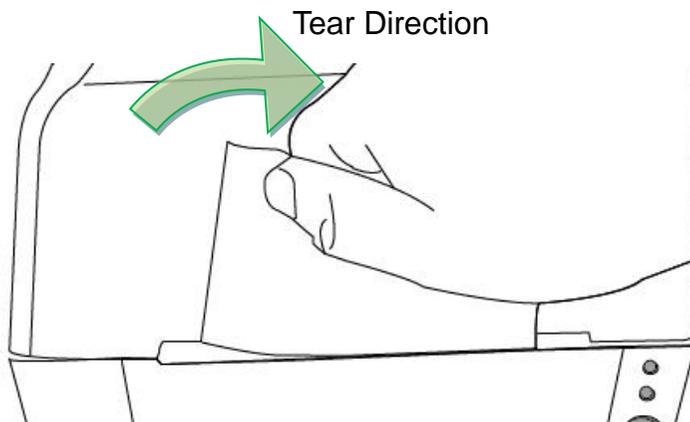

Media Sensor Type Setting

Multi-Column Label Setting by Software/ Driver

To index labels with multiple columns, please select media types to Multi-Column Labels in the label editing software Bartender UL.

Software setting steps:

Argox Bartender UL / Seagull Driver → Media Types →

Multi-Column Labels

Sample of labels with multiple columns:

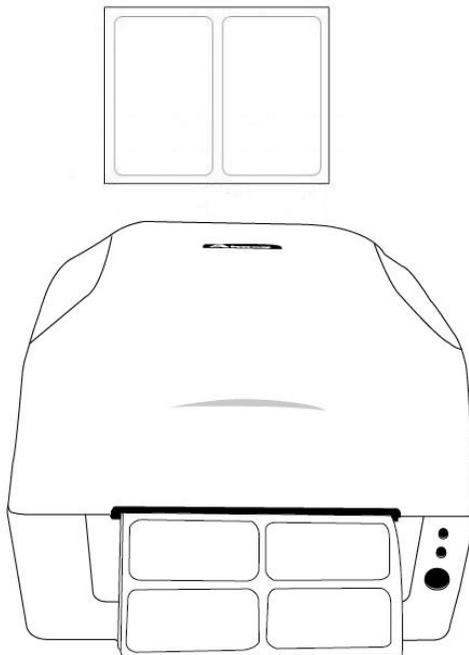

Loading Ribbon

The following steps only apply to thermal transfer printing mode only.

Direct thermal does not need ribbon to be installed.

Note:

- Media and ribbon types should be matched to provide with optimal print results.
- Always use ribbon that is wider than the media to protect the print head from wear.
- For direct thermal printing, do not load ribbon in the printer.

Preparing Ribbon

Find the two Ribbon Core Adaptors in printer package and fix them into new ribbon rolls from the left to the right.

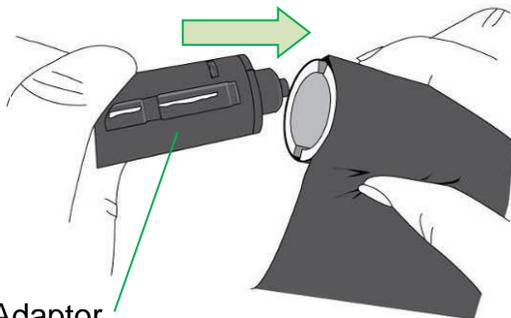

Ribbon Core Adaptor

Placing Ribbon Rolls

1. Gently press the recesses on both sides of the top cover of the printer (1), and then lift up the top cover of the printer to open (2).

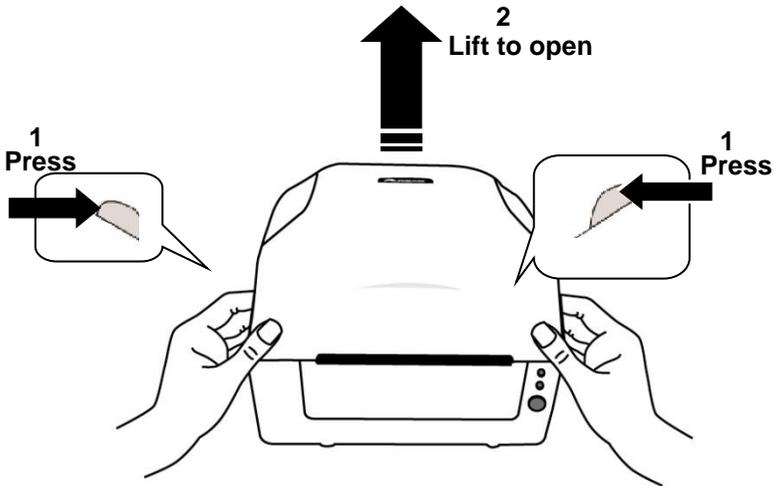

2. Push the Release Latch to open the printer module.

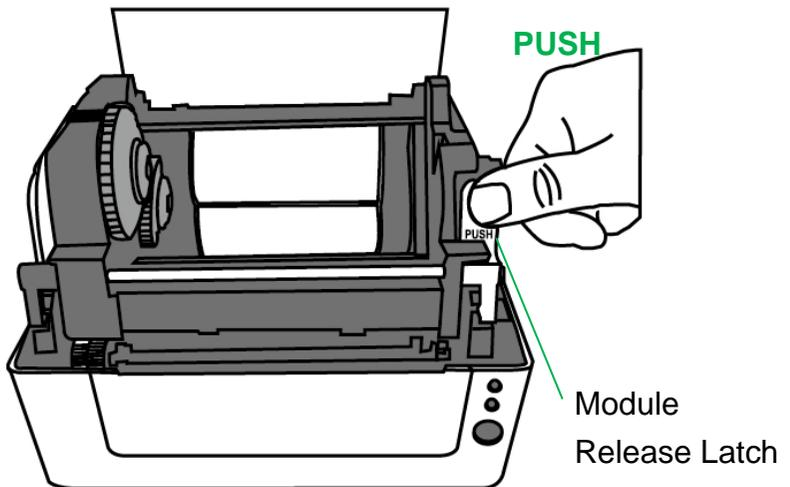

3. Lift up the printer module to check the Ribbon Supply Holder.

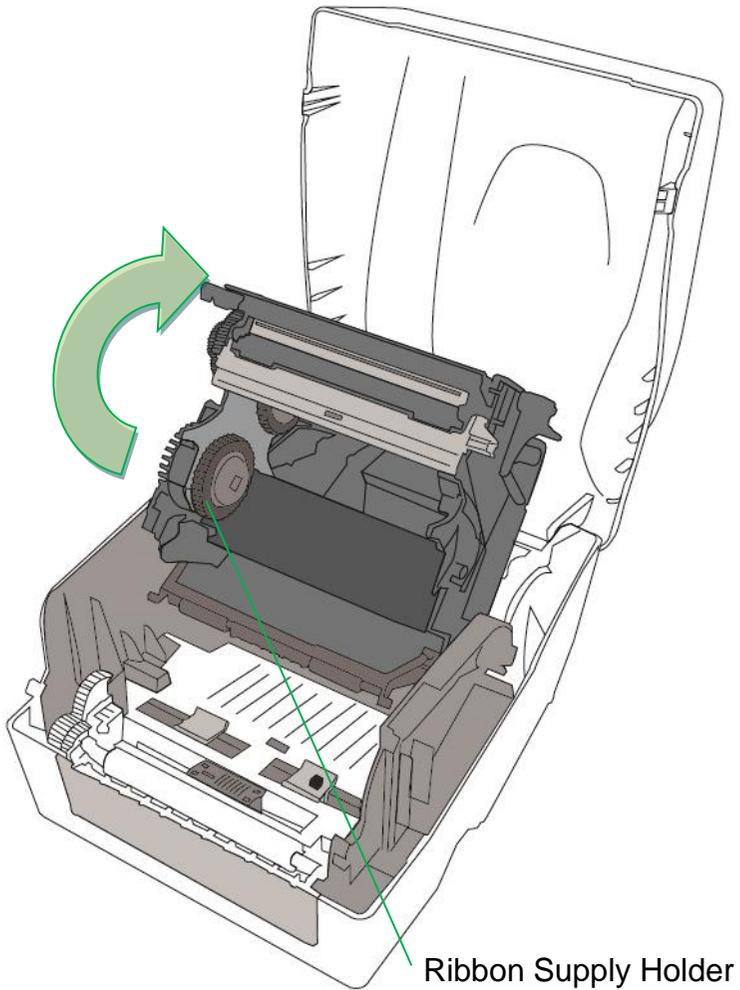

4. Install one ribbon roll and rotate it until the notches align and lock into the left side of Ribbon Supply hub, and then into the right.

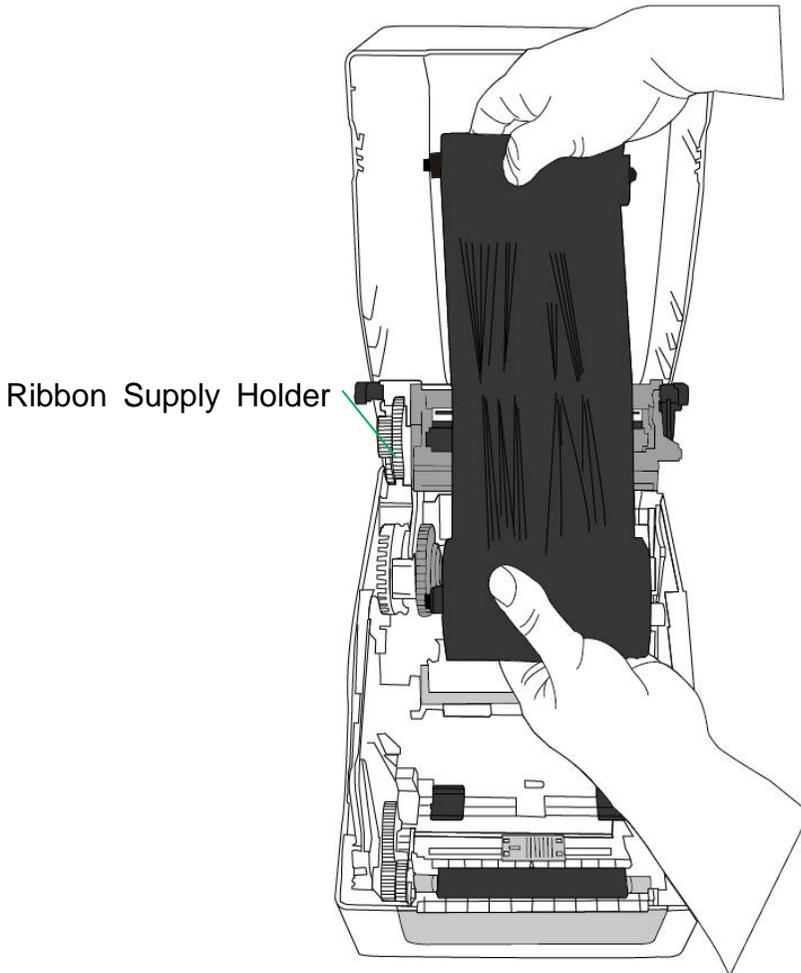

Note:

The Ribbon Supply Holder accepts the coated side of ribbon to be wound ink-side IN or wound ink-side OUT.

- lock into the left side of Ribbon Pick-up hub, and then the right.

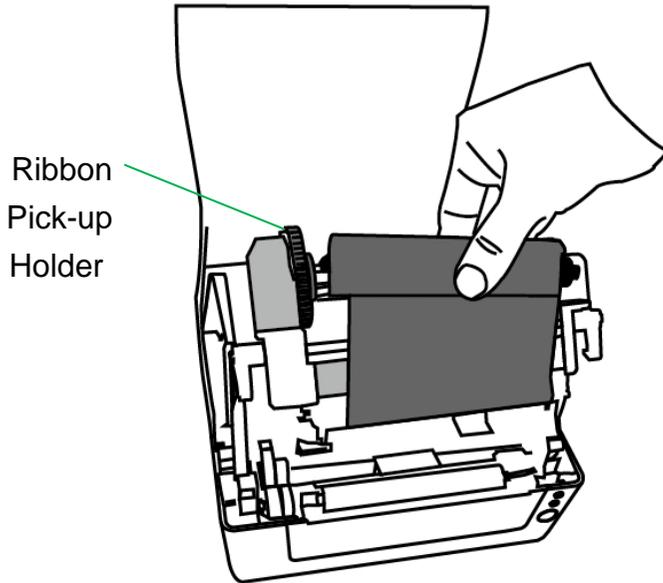

Note:

The Ribbon Pick-up Holder accepts the coated side of ribbon to be wound ink-side OUT only.

7. Close the printer module and then press firmly at the both sides to properly latch it until you hear a click.

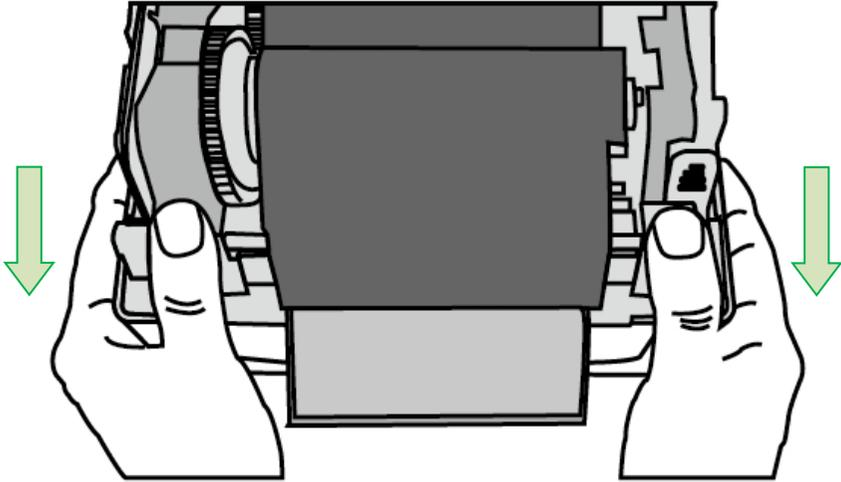

8. Rotate Thumb Wheel of Ribbon Pick-up Holder to remove slack and ribbon wrinkle, and to align the ribbon on the spindles.

Thumb Wheel

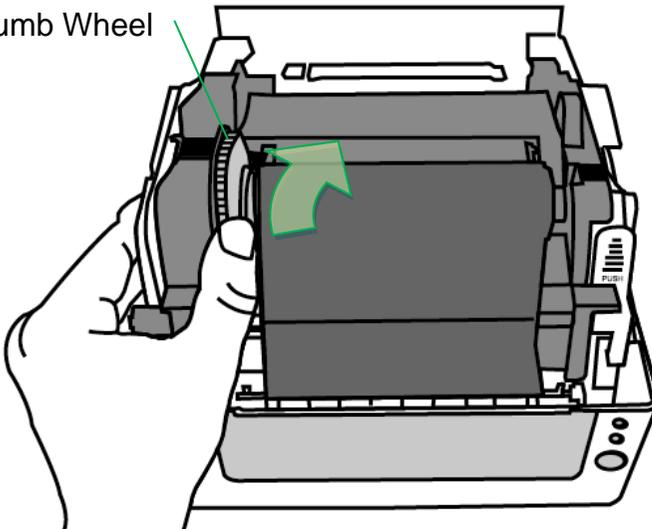

Printer Operation



Printing Media Calibration & Configuration

Before connecting the printer to your computer, to make sure that the printer works properly, conduct media calibration and print a self-test/ configuration label.

Steps to Start Media Calibration & Configuration

1. Make sure the media is properly loaded and the top cover of the printer is closed.
2. Turn off the printer power.
3. Press and hold the FEED button while turning on the power, until the printer motor starts.
4. Media Calibration will be performed while the printer automatically feeds the label stock for a certain length; then the printer motor suspends for one second and then prints out configuration/ self-test labels. Release the FEED button as soon as printer starts to print.

Note:

If printer is with Argox PPLB printer language, printer will enter Dump mode after printing configuration. In Dump mode, all characters will be printed in 2 columns: the right shows characters received from your system, and the left are the corresponding hexadecimal values of the characters. It allows users or engineers to verify and debug the program.

To return to normal operation mode from Dump mode, press the FEED button again. Another way is to turn off printer power, and then restart printer.

Sample of Printer Configuration Label

```
LABEL PRINTER WITH FIRMWARE
CP-2140EX-V01.00 20180823 PPLB _____ Model & F/W version
STANDARD RAM : 32M BYTES _____ Memory
AVAILABLE RAM : 3686K BYTES
FLASH TYPE : ON BOARD 16M BYTES
AVAILABLE FLASH : 8538K BYTES
NO. OF DL SOFT FONTS(FLASH) : 0
NO. OF DL SOFT FONTS(RAM) : 0
NO. OF DL SOFT FONTS(HOST) : 0
H. POSITION ADJUST.: 001A
SEE-THRU-2 SENSOR _____ Sensor type
REF: 009D SEE2: 0040
MAX LABEL HEIGHT: 100 INCHES
PRINT WIDTH: 816 DOTS
LAB LEN(TOP TO TOP): 80mm _____ Label length
SPEED: 5 IPS _____ Printing speed
DARKNESS: 8
THERMAL TRANSFER _____ Printing type
PRINT LENGTH: 9M _____ Printing length meter
CUT COUNT:0
RS232: 9600, 8, N, 1P, XON/XOFF _____ Serial port
CODE PAGE : English (437) _____ Code page
MEDIA : NON-CONTINUOUS _____ Media type
CALIBRATION MODE: INTELLI PRINT
BACKFEED DISABLED _____ Backfeed setting
CUTTER DISABLED _____ Cutter setting
PEELER DISABLED
CUTTER/PEELER OFFSET: 0 <+--0.01mm>
IP ADDRESS: 0.0.0.0
SUBNET MASK: 0.0.0.0
GATEWAY: 0.0.0.0
MAC ADDRESS: 12-34-56-78-90-14
DHCP: ENABLED
DHCP CLIENT ID: FFFFFFFFFFFFFFFF
FFFFFFFFFFFFFFF
```

Resetting Printer to Factory Defaults

Follow the steps below to reset printer to default settings:

1. Turn on the printer and wait till both "Ready" indicator and "Power" indicator stay solid green.
2. Press the "FEED" button for 4 seconds, and the "Ready" indicator and "Power" indicator will go off in order.
(at this step, if the "FEED" button is pressed for 8 seconds, printer will reset first >> feed blank labels as media calibration >> and then print configuration/ self-test labels.)
3. Once "Power" indicator becomes lit again, release the FEED button.
4. "Ready" indicator will then become lit, too. At this moment, the printer has resumed its factory default settings.
Printer will delete those print tasks received but not yet printed.

Note:

The printer factory default settings are stored in printer's flash; these settings remain stored, without being erased even the printer power is disconnected.

Printer Controls and Indicators

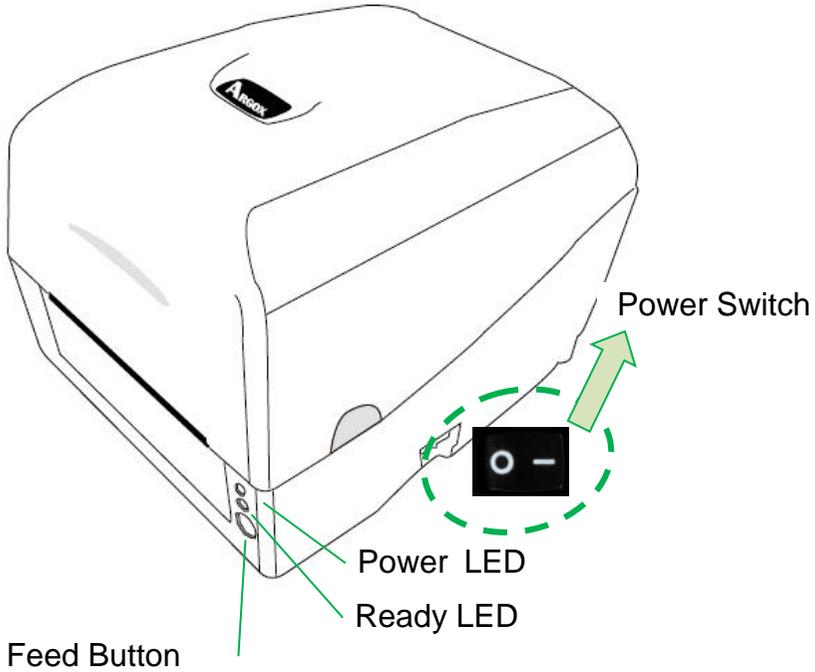

The following table explains printer controls and indicators' functions to help understanding LED indications and printer status:

Control / Indicator	Function
Power Switch	<ul style="list-style-type: none"> • On: turns on normal operation (at “I” position) • Off: turns off power (at “O” position) <p>Note: <i>Turn power off before connecting or disconnecting cables</i></p>
Power LED	<ul style="list-style-type: none"> • It will start blinking while “Media Out”, “Media Gap Not Found” or “Ribbon Out” has been detected. • Once printer cutter mode has been enabled, when Cutter is jammed with paper or Cutter is not installed, POWER indicator will blink. • When RS-232 communication error is detected, POWER indicator will blink.
Ready LED	<ul style="list-style-type: none"> • When printer is started, the READY indicator will blink. In Ethernet model, the READY indicator will blink for several seconds to wait till Ethernet Card is ready. • When printer receives data from host PC, READY indicator will start blinking. • READY indicator will blink when printing is paused.

	<ul style="list-style-type: none">• It will start blinking while “Media Out”, “Media Gap Not Found” or “Ribbon Out” has been detected.• It will blink as soon as the printer module is opened. <p>Note:</p> <p>When the print head is over-heated, printer’s thermal protection function will be activated and make READY LED blink to indicate printer is in PAUSE status to wait till print head has been cooled down. The printing tasks sent previously will be resumed automatically later.</p>
Feed Button	<ul style="list-style-type: none">• Press to advance the label media to the first printing position.• Press during printing to make printer "pause".• Press and hold while switching on the power to conduct media calibration and print out a configuration profile.• To resume printing after “Media Out “or “Ribbon Out “ errors have been resolved.

Troubleshooting by LED Indicators Diagnosis

Normally, when the printer is in not working properly, the "Power" LED blinks continuously, and printing and communication between the host and printer stops. Refer to LED indications listed below to understand possible solutions to resolve the problems printer run into.

LED Indicators: Power and Ready LEDs blink at the same tempo

Power LED	Ready LED
ON	ON
OFF	OFF

Possible Problems	Solutions	Remarks
Media sensor cannot index label gaps	Check the label path Check the label sensor	If a continuous label roll is in use, set "continuous media" printing in driver settings or commands.
Media out	Install a new label roll	
Paper jam	Recover the jam	

LED Indicators: Power and Ready LEDs blink alternately

Power LED	Ready LED
ON	OFF
OFF	ON

Possible Problems	Solutions	Remarks
Ribbon out	Install a new ribbon roll	Set “Direct Thermal” printing by driver or commands if no ribbon is required.

LED Indicators: Only the Power LED blinks

Power LED	Ready LED
ON	ON
OFF	ON

Possible Problems	Solutions	Remarks
Serial IO error	Check serial baud rate at both of your system and the printer.	For serial interface only
Cutter has failed, or there is paper jam inside the cutter.	Check the cutter or recover paper jam.	Only applicable in the cutter mode
Other possible hardware errors.	Contact the reseller for further service.	

LED Indicators: Only the Ready LED blinks

Power LED	Ready LED
ON	ON
ON	OFF

Possible Problems	Solutions
Print head needs to cool down	Printing will stop until the print head cools to normal printing temperature. Once it completes, the printer will automatically resume the printing tasks sent previously.
Printer head module unlatched	Close the printer module and then press firmly at both the left and the right sides of printer module to latch.
Printer is in PAUSE status	Press FEED button to resume printing.
Printer is receiving data	As soon as all the data is received, Ready LED will stay solid green and automatically resume normal operation.

Miscellaneous

If the host shows "Printer Time out":

1. Check if the communication cable (serial) is connected securely to your serial port on the PC and to the connector on the printer at the other end.
2. Check if the printer power is turned on.

If the data has been sent, but there is no output from the printer. Check the active printer driver, and see if Seagull driver for your Windows system and the label printer has been selected.

Vertical streaks in the printout usually indicate a dirty or faulty print head. (Refer to the following examples.)

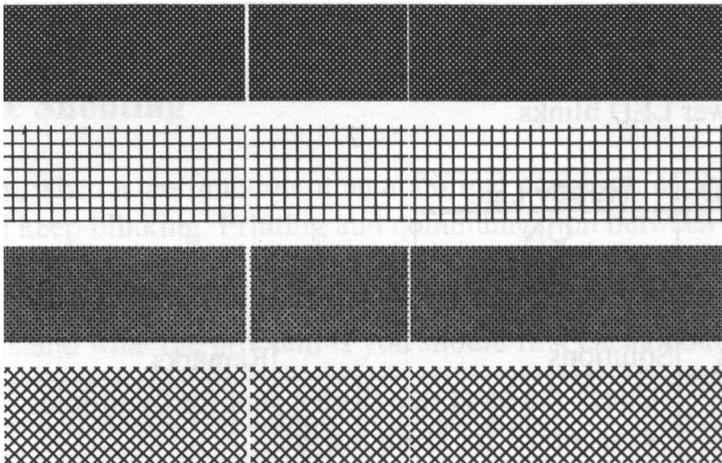

Clean the print head. If the problem persists, replace the print head.

Poor printout quality:

- The ribbon may not be qualified.
- The media may not be qualified.
- Adjust the Darkness (heat temperature).
- Slow down the print speed.
- Refer to the next chapter and clean the related spare parts.

Recovery

After correcting problems, simply press the panel button or restart the printer to continue your print jobs. Make sure the LEDs are not blinking and remember to resend your files.

Communications

Interfaces and Requirements

Argox CP / CX printer series come with a 9-pin Electronics Industries Association (EIA) RS-232 serial data interface, USB (Host/Device) interface, and Ethernet. A variety of interface options are suitable for versatile applications:

CP-2140EX / CX-2140: USB (Host/Device), Ethernet, and Serial interfaces

Note:

1. You must insert the power supply's barrel connector into the power jack on the back of the printer before connecting communication cables.
2. This printer complies with FCC Rules and Regulations, Part 15, for Class A Equipment, for use with fully shielded six-foot data cables. Use of longer cables or unshielded cables may increase radiated emissions above Class A limits.

USB Interface Requirements

The Universal Serial Bus (USB) interface is compatible with your existing PC hardware. The USB's "plug and play" design makes installation easy. Multiple printers can share a single USB port/hub.

Serial (RS-232) Interface Requirements

The required cable must have a 9-pin "D" type male connector on one end, which is plugged into the mating serial port located on the back of the printer. The other end of the signal interface cable connects to a serial port on the host computer.

Note:

For technical and pin-out information, please refer to the Technical Reference, Interface Specifications in this manual.

Serial and Parallel Cabling Requirements

Data cables must be of fully shielded construction and fitted with metal or metalized connector shells. Shielded cables and connectors are required to prevent radiation and reception of electrical noise.

To minimize electrical noise pickup in the cable:

1. Keep data cables as short as possible.
(6 ft or 1.83m recommended)
2. Do not tightly bundle the data cables with power cords.
3. Do not tie the data cables to power wire conduits.

Ethernet 10/100 Internal Printer Server Option

This connector is for Ethernet application; it is convenient to use several printers by Ethernet connector at the same time.

Note:

When using Ethernet model printer, please wait until the Ready Indicator stops blinking, before starting printer operations.

Ethernet Status Indicators

LED Status	Description	
Both Off	No Ethernet link detected.	
Blinking	The printer waits for printer ready. It will take about 20 seconds to be ready.	
Green	Speed LED	On: 100 Mbps link Off: 10 Mbps link
Amber	Link/Activity LED	On: link up Off: link down Flash: activity

Ethernet LED Indicators:

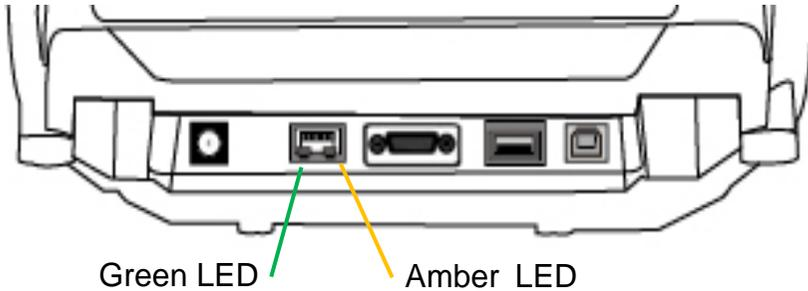

Communicating with the Printer

The bundled printer driver can be applied to all applications under Windows Vista/ Windows 7/ Windows 8/ Windows 10, supporting 32-bit/ 64-bit operation systems. With this driver you can operate any popular Windows software applications including Argox Bartender UL label editing software or MS Word, etc., to print to this printer.

Drivers can be downloaded from Argox website.

Installing a Plug and Play printer driver (for USB only)

Note:

We strongly recommend that you use the Seagull Driver Wizard instead of the Microsoft Windows Add Printer Wizard when installing and updating your Drivers by Seagull. (Even though the "Add Printer Wizard" is from Microsoft, it too easily performs a number of tasks incorrectly when updating existing drivers. It also badly handles the situation where a printer driver is already in use by a Windows application.)

1. Turn off the printer. Plug the power cable into the power socket on the wall, and then connect the other end of the cable to printer's power socket. Connect the USB cable to the USB port on the printer and on the PC.

2. Turn on the printer. If the printer supports Plug-and-Play, and you have successfully connected it using a USB cable, then the Windows Add Hardware Wizard will automatically detect the printer and display a dialog that allows you to install a driver. Click Cancel and do not install the driver using this wizard.
3. Run the driver from Argox website. On the prompt, Windows Printer Driver, select "I accept..." and click "Next".

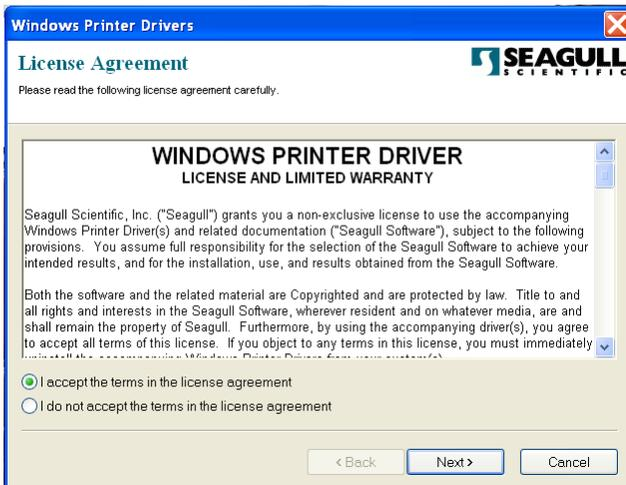

- Assign the directory to keep Seagull driver, (for example, C:\Seagull) and click "Next".

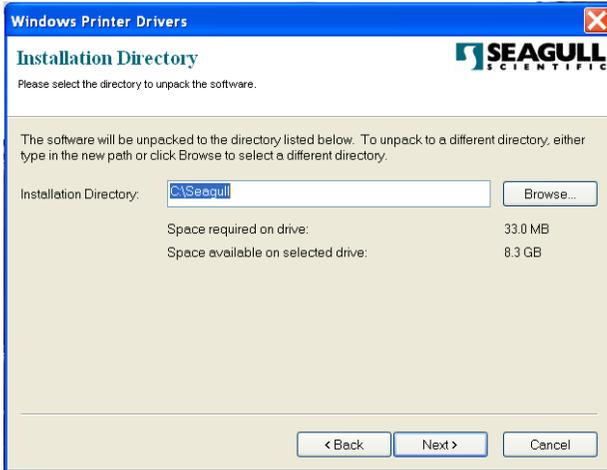

- Click "Finish".

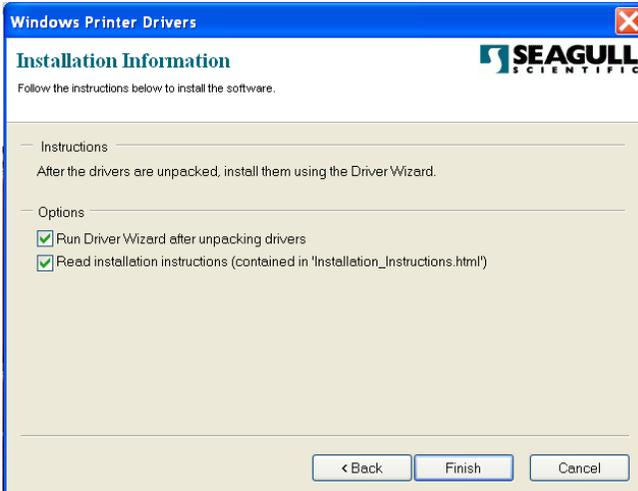

6. Select Install printer drivers and Click "Next".



7. On the Seagull Driver Wizard prompt, select the first radio button to "Install a driver for a Plug and Play printer". Then click "Next".

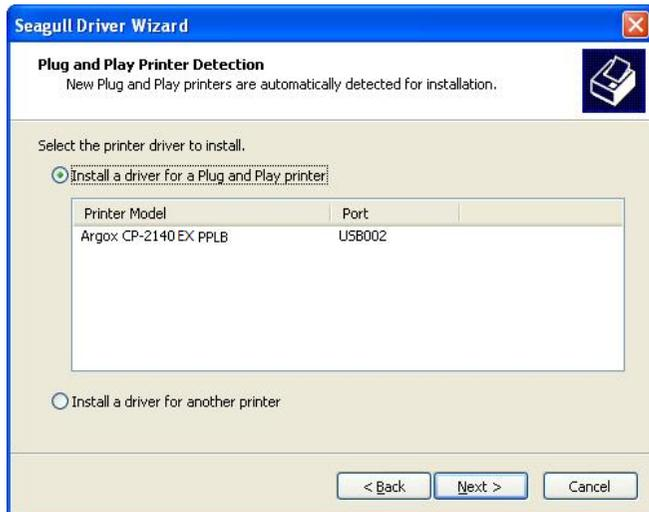

8. Enter Printer name (i.e. Argox CP-2140EX PPLB) and select "do not share this printer", and click "Next".

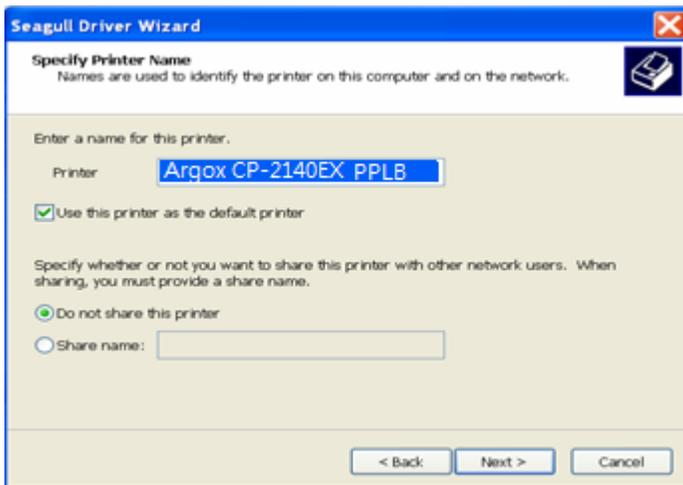

9. Check all the data on the showing screen, if it is correct, click "Finish".

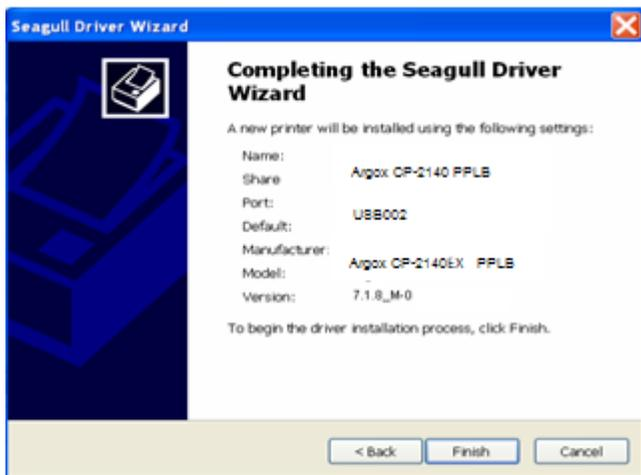

10. After copying of the related files to your system is finished, click "Finish".

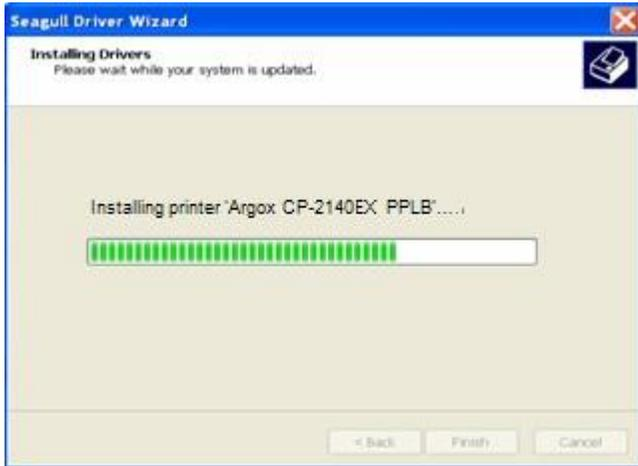

11. After driver installation is complete, click "Close".
The driver is now be installed.



Installing a Printer Driver (for other interfaces except USB)

1. Turn off the printer. Plug the power cable into the power socket on the wall, and then connect the other end of the cable to printer's power socket. Connect the Parallel cable, Serial cable, or Ethernet cable to the proper port on the printer and on your computer.
2. Run the driver from Argox website. On the prompt, Windows Printer Driver, select "I accept..." and click "Next".

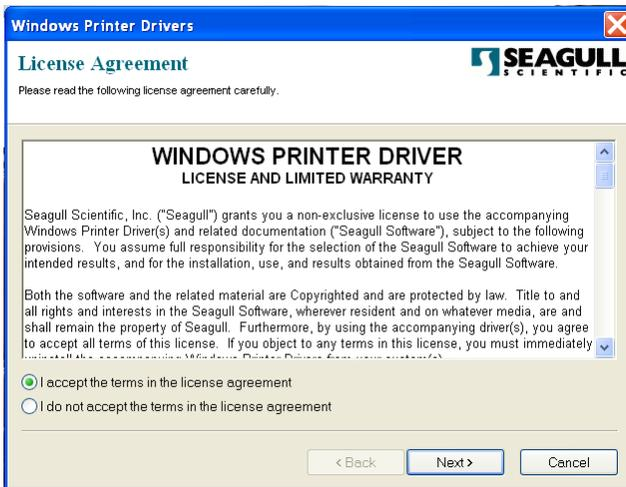

3. Assign the directory to keep Seagull driver, (for example, C:\Seagull) and click "Next".

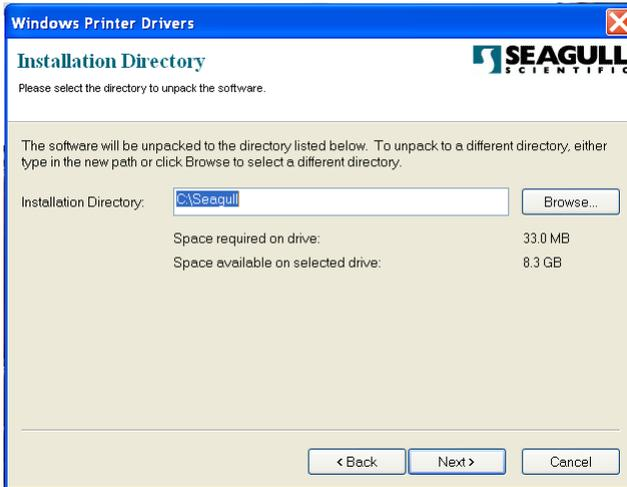

4. Click "Finish".

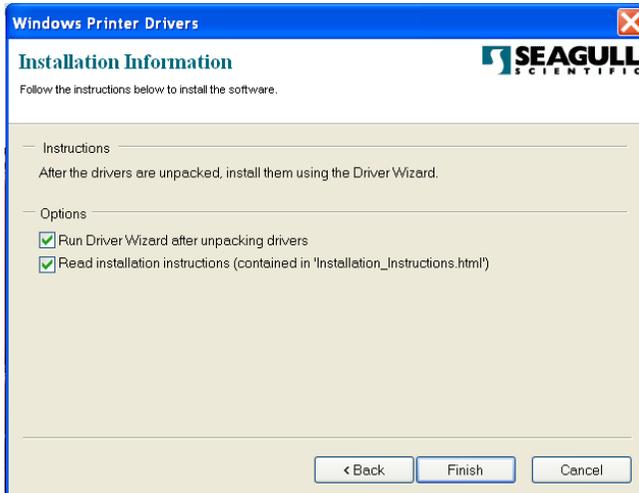

5. Select Install printer drivers and Click "Next".



6. Make sure that the printer connects to your PC, select "Other" and click "Next".



7. Select model and emulation - the following examples are based on model CP-2140EX PPLB.

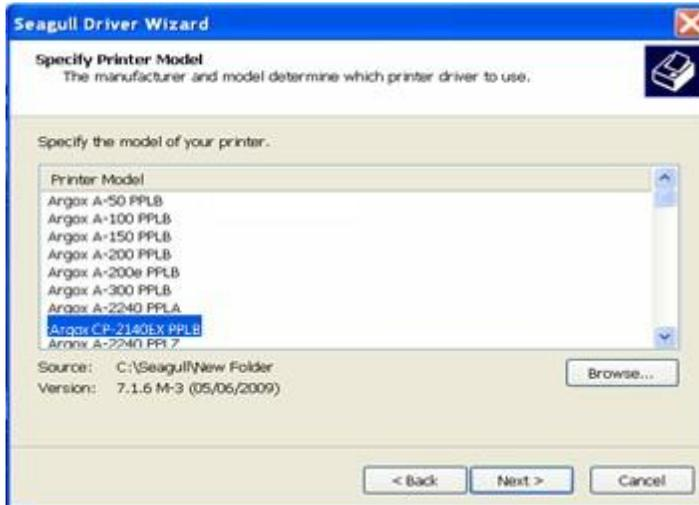

8. Select the port of the printer and click "Next".

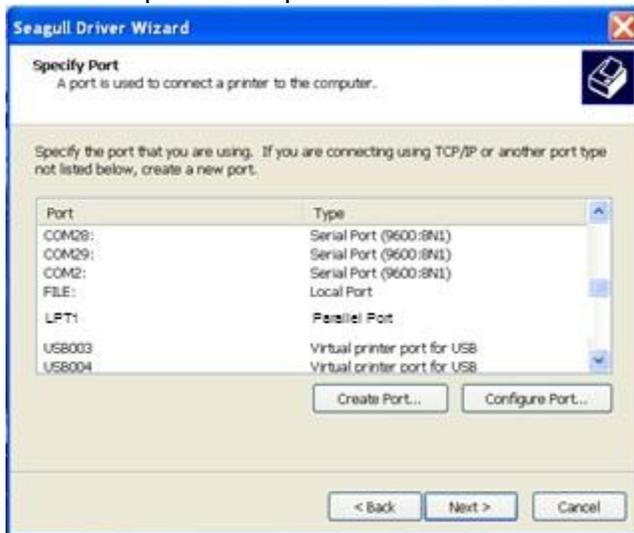

9. Enter Printer name (i.e. Argox CP-2140EX PPLB) and select "do not share this printer", and click "Next".



10. Check all the data on the showing screen, if it is correct, click "Finish".



11. After copying of the related files to your system is finished, click "Finish".

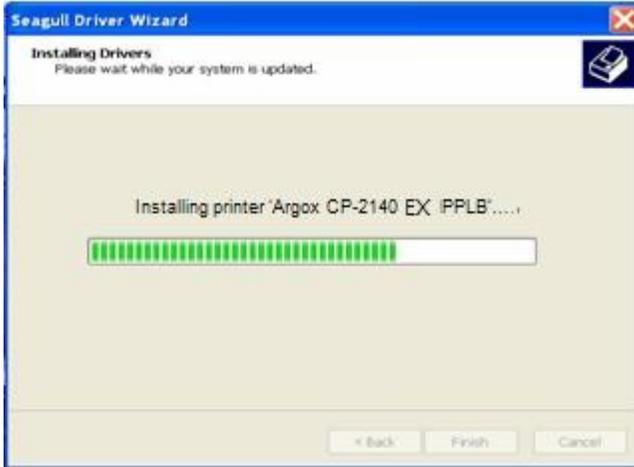

12. After driver installation is complete, click "Close".
The driver is now installed.



Caring for Your Printer

Print Head Maintenance Guide

To keep the Print Head remain in the best conditions and efficiency and to extend duration for use, regular cleaning action is needed:

Note: Always switch off printer power before cleaning. In case of long-time printing, surface of print head may be very hot. Please wait till print head cools down properly before maintenance, to prevent burns. During maintenance, do not directly touch print head surface, to avoid its damage and any possible injury to you. Use cleaning material instead.

Cleaning Interval

It's strongly recommended to regularly clean print heads at least when changing every one label roll (in direct thermal printing mode) or every one ribbon roll (in thermal transfer printing mode). In addition, if printers are operated under critical applications and environments, or if it's found that print quality is degraded, please clean print heads more frequently.

Cleaning Material

Surface of print head's heating element is very fragile. To prevent from any possible damage, please use soft cloth/ cotton buds with "Ethanol" or "IPA" to clean print head surface.

It's strongly recommended to wear hand gloves during cleaning progress.

Do not touch print head surface by bare hands or with any hard equipment.

Water or spit should be kept away in case of corrosion on heating elements.

Cleaning Direction

When cleaning the print head, always wipe in One-Way Direction - from Left to Right only, or, from Right to Left only, to clean "Heating Line" of print head gently without excessive stress.

Do not wipe back and forth, to avoid dust or dirt on cleaning cotton would be attached onto print head again.

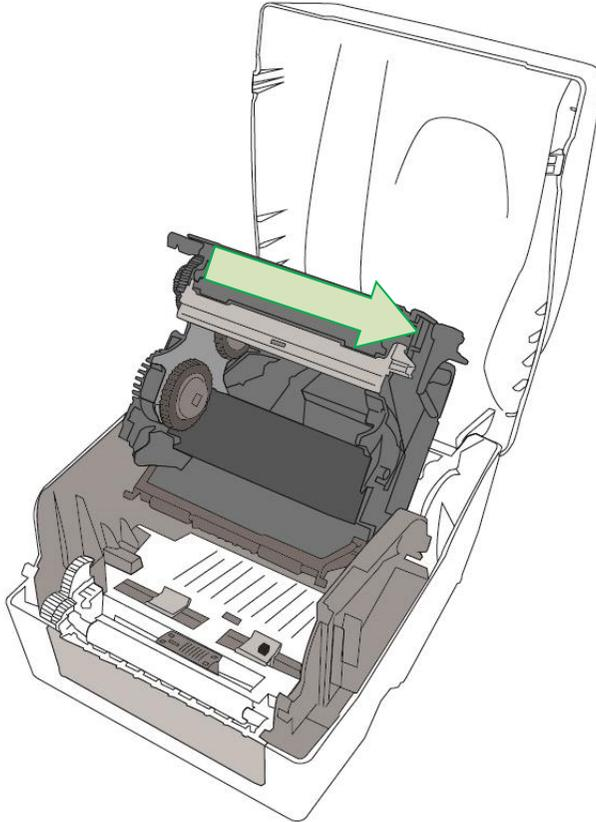

Special Caution:

Warranty of the print head will be void if the print head serial number is removed, altered, defected, or made illegible under every circumstance.

Configuring Your LAN Printer by Web Setting Tool



Before doing settings for your printer, be sure that you have a LAN cable. The cable is connected to the LAN connector of your printer. The LAN connector is an 8-PIN RJ45 type modular connector. Please use the LAN cable of CAT 5 of a proper length to connect the LAN connector on the printer to a LAN hub as appropriate.

The default static IP address of the printer is 0.0.0.0 and the default listen port is 9100. For the first time, to configure your printer through the web setting tool, you must still follow the step-by-step instructions below.

Attaching the power cord

1. Make sure the printer power switch is set to the **OFF** position.
2. Insert the power supply's connector into the printer power jack.
3. Insert the AC power cord into the power supply.

Important: *Use only the power supply listed in the user instructions.*

4. Plug the other end of the AC power cord into the wall socket.



Do not plug the AC power cord with wet hands or operate the printer and the power supply in an area where they may get wet. Serious injury may result from these actions!

Connecting your LAN printer to a LAN hub

Use a LAN cable of CAT 5 of a proper length to connect the LAN connector on the printer to a LAN hub to which your desktop or laptop PC as a host terminal is also connected.

Getting the IP address of your LAN printer

You can have the printer run a self test to print a configuration label, which helps you get the IP address of your printer connected to the LAN hub.

1. Turn off the printer.
2. Press and hold the **FEED** button, and turn on the printer.
3. Both status lights glow solid amber for a few seconds. Next, they turn to green shortly, and then turn to other colors. When LED 2 turns to green and LED 1 turns to amber, release the **FEED** button.
4. Press the **FEED** button to print a configuration label.
5. Get the IP address of the printer from the printed configuration label.

Logging in to the web setting tool

The Web Setting Tool is a build-in setting tool in firmware for ARGOX serial printers. User can connect to the supported ARGOX serial printers with browsers to get or set the printer settings, update firmware, download font, etc.

After obtaining the IP address of the LAN printer from the printed configuration label, you can connect to the printer with the supported browsers by input the IP address of the printer, *for example, 192.168.6.185*, in the URL field and connect to it.

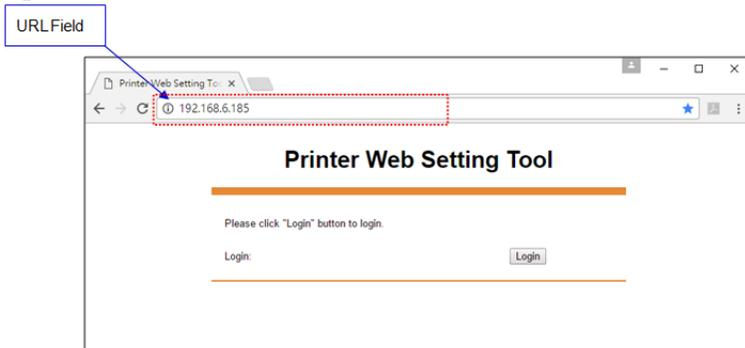

When the connection is successful, the Login page will be displayed. Input the user name and password to log in to the web setting tool. The default user name and the default password are given below:

Default user name: admin

Default password: admin

The default password can be changed in the "Device Setting \ Change Login Password" webpage.

This web setting tool can be used to manage multiple label printers in the same local area network segment under the Windows operating system as long as there is no conflicting IP address in the network. You can also check each of the MAC addresses listed in this tool against the MAC address label you can find on each of the printers.

The label printer that is connected through TCP/IP in the way like a directly connected local printer can be used with a random PC connected in the same local area network segment. So, through the tool, all commands applicable to the LAN mode can work on the printer in the same way, as the printer must be configured upon the TCP/IP communication protocol with the IP address of the printer.

When doing settings through a tablet PC or Smart Phone for the printer working in infra mode, please set the same network segment of the host terminal to that of the printer, for example, 192.168.6.XXX (1~254). The Wi-Fi mode for the printer is infra mode that can be searched by the wireless device manager of the host terminal.

Product Specification

General Specification

	CP-2140EX/ CX-2140	CP-3140EX / CX-3140
Printing Method	Direct Thermal / Thermal Transfer	
Printing Resolution	203 dpi (8 dots/mm)	300 dpi (12 dots/mm)
Printing Speed	2~6 ips	2~4 ips
Printing Length	Max 100" (2540mm)	Max 50" (1270mm)
Printing Width	Max 4.25" (108mm)	Max 4.16" (105.7mm)
Memory	32MB DRAM (3.6MB available for user) / 16MB Flash ROM (8.4MB available for user)	
CPU Type	32-bit RISC microprocessor	
Sensors	Media Reflective sensor x 1 (movable) & Media Transmissive sensor x 1 (centrally positioned) / Head open switch / Ribbon end sensor	
Media Type	Roll-feed, die-cut, continuous, fan-fold, black mark, tag, ticket, in the thermal paper and plain paper	
Media	Max Width: 4.65" (118mm) Min Width: 0.8" (20mm) Thickness: 0.0025"~0.008" (0.06~0.2mm) Max. roll capacity (OD): 5" (127 mm) Core size: 1" (25.4mm) Max. roll capacity (OD): 4.5" (114.3 mm) Core size: 0.5" (12.7mm) Max. roll capacity (OD): 4.7" (120 mm) Core size: 1.5" (38.1mm)	
Ribbon	Ribbon Width: 1"~4.33" (25.4mm~110mm), Ribbon Length: max 300m , Core size – ID: 1"(25.4mm) / 0.5"(12.7mm)(optional) Core width – max OD: 2.6"(67mm) Wax, Wax/Resin, Resin (Ribbon wound ink-side out or ink-side in)	
Operation Interface	LED indicator (Power/Ready)x 2, Button(Feed) x 1	

	CP-2140EX/ CX-2140	CP-3140EX / CX-3140
Communication Interface	USB (Host/Client), LAN (10/100Mbps), Serial (RS-232)(transmission rate: up to 115200 bps)	
Emulation	PPLA, PPLB, PPLZ	
Driver tools	Argox Seaguall Driver (Windows Vista/Win7/Win8/Win10) / Argox Linux Printer Driver / Argox macOS Printer Driver / Argox RPi Printer Driver	
Label Editing Software	BarTender® from Seaguall Scientific Argobar Pro support ODBC Database Connection: Excel CSV, MS Access, MS SQL, Oracle, MySQL, dBASE (*.dbf)	
Software	BarTender, Printer Tool	
Power Source	Universal Switching Power Supply AC Input: 100~240V, 1.8A, 50-60Hz, Output: 24VDC, 2.5A	
Dimensions	W 226mm x H 188mm x D 276mm	
Weight	2.1kg (4.6 lbs)	
Operation Environment	Operation Temperature: 40°F~100°F (4°C~38°C), 10% ~ 90% non-condensing, Storage Temperature: -4°F~122°F (-20°C~50°C)	
Optional Items	Media Stacker, Cutter, Peeler	
Agency Listing	CE, FCC,CUL,CCC, RoHS, BSMI, BIS, KC	

Fonts, Barcodes, and Graphics Specification

The specifications of fonts, bar codes and graphics depends on the printer emulation. The emulations PPLA, PPLB, and PPLZ are printer-programming languages, through which the host can communicate with your printer.

Printer Programming Language PPLA

Programming Language	PPLA
Internal fonts	9 fonts with different point size 6 fonts with ASD smooth font. Courier font with different symbol sets.
Symbol sets (Code pages)	Courier font symbol set: Roman-8, ECMA-94, PC, PC-A, PC-B, Legal, and PC437 (Greek), Russian.
Soft fonts	Multibyte Character Set, for Traditional Chinese, Simplified Chinese, Korean, and Japanese, downloadable by printer tool
Font size	1x1 to 24x24 times
Character rotation	0, 90, 180, 270 degree, 4 direction rotation
Graphics	PCX, BMP, IMG, HEX and GDI format files
1D Barcodes	Code 39, UPC-A, UPC-E, Code 128 subset A/B/C, EAN-13, EAN-8, HBIC, Codabar, Plessey, UPC2, UPC5, Code 93, Postnet, UCC/EAN-128, UCC/EAN-128 K-MART, UCC/EAN-128 Random weight, Telepen, FIM, Interleaved 2 of 5 (Standard/with modulo 10 checksum/ with human readable check digit/ with modulo 10 checksum & shipping bearer bars), and GS1 Data bar (RSS)
2D Barcodes	MaxiCode, PDF417, Data Matrix (ECC 200 only), QR code, and Composite Codes

Printer Programming Language PPLB

Programming Language	PPLB
Internal fonts	5 fonts with different point size
Symbol sets (Code pages)	8 bits code page : 437, 850, 852, 860, 863, 865, 857, 861, 862, 855, 866, 737, 851, 869, 1252, 1250, 1251, 1253, 1254, 1255 7 bits code page: USA, BRITISH, GERMAN, FRENCH, DANISH, ITALIAN, SPANISH, SWEDISH and SWISS (300dpi printer models support Code page 437, 850, 852, 860, 863, 865, 1254 only)
Soft fonts	Multibyte Character Set, for Traditional Chinese, Simplified Chinese, Korean, and Japanese, downloadable by printer tool
Font size	1x1 to 24x24 times
Character rotation	0, 90, 180, 270 degree, 4 direction rotation
Graphics	PCX, BMP, Binary Raster, and GDI
1D Barcodes	Code 39, UPC-A, UPC-E, Matrix 2 of 5, UPC-Interleaved 2 of 5, Code 39 with check sum digit, Code 93, EAN-13, EAN-8 (Standard, 2/5digit add-on), Codabar, Postnet, Code128 subset A/B/C, Code 128 UCC (shipping container code) , Code 128 auto, UCC/EAN code 128 (GS1-128), Interleave 2 of 5, Interleaved 2 of 5 with check sum, Interleaved 2 of 5 with human readable check digit, German Postcode, Matrix 2 of 5, UPC Interleaved 2 of 5, EAN-13 2/5 digit add-on, UPCA 2/5 digit add-on, UPCE 2/5 digit add-on, and GS1 Data bar (RSS)
2D Barcodes	MaxiCode, PDF417, Data Matrix (ECC 200 only), QR code, and Composite Codes

Printer Programming Language PPLZ

Programming Language	PPLZ
Internal fonts	8 (A~H) fonts with different point size. 8 AGFA fonts: 7 (P~V) fonts with fixed different point size (not scalable). 1 (0) font with scaling point size.
Symbol sets (Code pages)	USA1, USA2, UK, HOLLAND, DENMARK/NORWAY, SWEDEN/FINLAND, GERMAN, FRANCE1, FRANCE2, ITALY, SPAIN, MISC, JAPAN, IBM850
Soft fonts	Multibyte Character Set, for Traditional Chinese, Simplified Chinese, Korean, and Japanese, downloadable by printer tool
Font size	1x1 to 10x10
Character rotation	0, 90, 180, 270 degree, 4 direction rotation
Graphics	GRF, Hex and GDI
1D Barcodes	Code39, UPC-A, UPC-E, Postnet, Code128 subset A/B/C, Interleave 2 of 5, Interleaved 2 of 5 with check sum, Interleaved 2 of 5 with human readable check digit, Code 93, Code 39 with check sum digit, MSI, EAN-8, Codabar, Code 11, EAN-13, Plessey, GS1 Data bar (RSS), Industrial 2 of 5, Standard 2 of 5, and Logmars
2D Barcodes	QR code, PDF417, Data Matrix (ECC 200 only), and MaxiCode Composite Codes

Interface Specification

This section presents the interface specifications of I/O ports for the printer. These include pin assignments, protocols and detailed information about how to properly interface your printer with your host or terminal.

USB Interface

Connector Terminal Pin Assignment

Pin	Signal	Description
1	VBUS	5V
2	D -	Differential data signaling pair -
3	D +	Differential data signaling pair +
4	GND	Ground

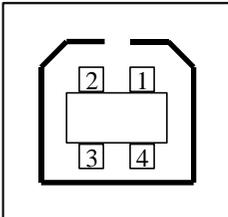

USB series "B" Receptacle Interface

Ethernet Interface

The following port complies with Ethernet communication.

Pin	Signal
1	Transmit+
2	Transmit-
3	Receive+
4	Reserved
5	Reserved
6	Receive-
7	Reserved
8	Reserved

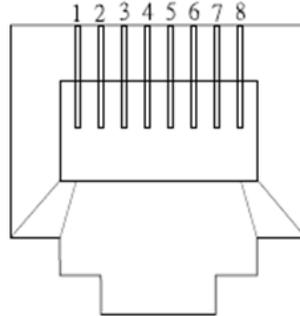

The RS232 connector on the printer side is a female, DB-9.



Pin	Signal	Description
1	No function	Shorted to Pins 4 and 6
2	Out	TxDATA
3	In	RxDATA
4	No function	Shorted to Pins 1 and 6
5	GND	Signal Ground
6	No function	Shorted to Pins 1 and 4
7	In	CTS
8	Out	RTS
9		N.C.

Connection with Host

Host 25S (PC or compatible)	Printer 9P	Host 9S (PC or compatible)	Printer 9P
--------------------------------	------------	-------------------------------	------------

DTR 20	1 DSR	DTR 4	1 DSR
DSR 6	6 DTR	DSR 6	6 DTR
TX 3	3 RX	TX 3	3 RX
RX 2	2 TX	RX 2	2 TX
CTS 5	8 RTS	CTS 8	8 RTS
RTS 4	7 CTS	RTS 7	7 CTS
GND 7	5 GND	GND 5	5 GND

Alternatively you can just connect the 3 wires in the following way.

Host 25S (PC or compatible)	Printer 9P	Host 9S (PC or compatible)	Printer 9P
--------------------------------	------------	-------------------------------	------------

TX 3	3 RX	TX 3	3 RX
RX 2	2 TX	RX 2	2 TX
GND 7	5 GND	GND 5	5 GND
pin 4	<input type="text"/>		pin 4	<input type="text"/>	
pin 5	<input type="text"/>		pin 6	<input type="text"/>	
pin 6	<input type="text"/>		pin 7	<input type="text"/>	
pin 20	<input type="text"/>		pin 8	<input type="text"/>	

The simplest way to connect to other hosts (not PC compatible) or terminals is:

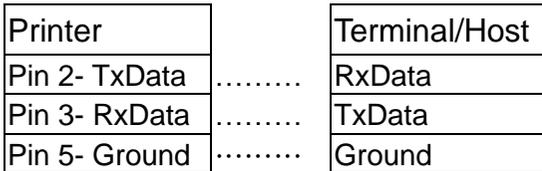

In general, as long as the data quantity is not too large and you use Xon/Xoff as flow control, it will be problem free.

Baud rate: 2400, 4800, 9600(default), 19200, 38400, 57600, 115200 bauds.(programmable by command)

Data format: always 8 data bits, 1 start bit and 1 stop bit.

Parity: always non-parity

Handshaking: XON/XOFF as well as CTS/RTS (hardware flow control)

If you run an application with the bundled printer driver under Windows and use the serial port, you should check the above parameters and set the flow control to "Xon/Xoff "or "hardware".

Dimensions

