



O4 Series Printer

User Manual

O4-250 / O4-350



<http://www.argo.com>
service@argo.com

Media



[Installation Video]

Ribbon



[Installation Video]

Version: 1.5

FCC ID

In a domestic environment this product may cause radio interference in which case the user may be required to take adequate measures.

FCC Warning

This equipment has been tested and found to comply with the limits for a Class A digital device, pursuant to Part 15 of the FCC Rules. These limits are designed to provide reasonable protection against harmful interference when the equipment is operated in a commercial environment. This equipment generates, uses, and can radiate radio frequency energy, and if not installed and used in accordance with the instructions in this manual, it may cause harmful interference to radio communications. Operation of this equipment in a residential area is likely to cause harmful interference in which case the user will be required to correct the interference at his own expense.

FCC Statement for Optional RF module

This device complies with RF radiation exposure limits set forth for an uncontrolled environment.

The antenna used for this transmitter must be installed to provide a separation distance of at least 20 cm from all people and must not be collocated or operating in conjunction with any other antenna or transmitter.

Bluetooth/Wireless LAN Communication

Compliance Statement

This product has been certified for compliance with the relevant radio interference regulations of your country or region. To make sure continued compliance, do not:

- Disassemble or modify this product.
- Remove the certificate label (serial number seal) affixed to this product.

Use of this product near microwave and/or other Wireless LAN equipment, or where static electricity or radio interference is present, may shorten the communication distance, or even disable communication.

WARNING

Changes or modifications not expressly approved by the party responsible for compliance could void the user's authority to operate the equipment.

(for USA only)

Liability Disclaimer

ARGOX Corporation takes steps to assure that the company's published engineering specifications and manuals are correct; however, errors do occur. ARGOX reserves the right to correct any such errors and disclaims any resulting liability. In no event shall ARGOX or anyone else involved in the creation, production, or delivery of the accompanying product (including hardware and software) be liable for any damages whatsoever (including, without limitation, damages for loss of business profits, business interruption, loss of business information, or other pecuniary loss) arising out of the use of or the results of use of or inability to use such product, even if ARGOX has been advised of the possibility of such damages.

Caution

Any changes or modifications not expressly approved by the party responsible for compliance could void the user's authority to operate the equipment.

Contents

1	Introduction	1
1.1	Features.....	1
1.2	Unpacking.....	2
1.3	Understand your printer	3
1.3.1	Perspective view	3
1.3.2	Back view	4
1.3.3	Interior view I	5
1.3.4	Interior view II	6
1.4	Printer lights.....	7
1.4.1	Status lights.....	7
1.4.2	System mode.....	10
2	Get started	11
2.1	Attach the power cord	11
2.2	Turn on/off your printer	12
2.2.1	Turn on your printer	12
2.2.2	Turn off your printer	12
2.3	Load media.....	13
2.3.1	Prepare media.....	13
2.3.2	Place a media roll.....	14
2.3.3	Test media feed	17
2.4	Media types.....	18
2.5	Placing Ribbon Roll.....	20
2.6	Media sensing	23
2.6.1	Transmissive sensor	23
2.6.2	Reflective sensor	24
3	Printer operation.....	25
3.1	Printing Media Calibration & Configuration	25
3.2	Self-test	26
3.3	Restore your printer	37
3.4	Communications	38
3.4.1	Interfaces and Requirements.....	38
3.5	Driver installation.....	40
3.5.1	Installing a Plug and Play printer driver (for USB only)	41
3.5.2	Installing a Printer Driver (for other interfaces except USB).....	47
4	Configuration on Web Setting Tool.....	53
4.1	Attaching the power cord	53

4.2	Connecting the printer to a LAN hub	53
4.3	Getting the IP address of the printer	54
4.4	Logging in to the web setting tool	54
5	Maintenance	56
4.1	Cleaning.....	56
4.1.1	Printhead.....	56
4.1.2	Media housing	57
4.1.3	Sensor.....	57
4.1.4	Platen roller.....	58
6	Troubleshooting	59
5.1	Printer issues	59
5.2	Media issues.....	60
5.3	Ribbon Problems	61
5.4	Other issues.....	62
7	Specifications	63
6.1	Printer.....	63
6.2	Media	65
6.3	Electrical and operating environment.....	66
6.4	Physical dimension	66
6.5	Fonts, Barcodes, and Graphics Specification	67
6.6	Ethernet	70
6.7	Bluetooth (Option).....	70
6.8	Wireless LAN (Option).....	71
6.9	Interfaces.....	72
6.9.1	USB	72
6.9.2	Ethernet	74
6.9.3	RS-232C.....	75

1 Introduction

Thank you for purchasing an Argox O4 Series barcode printer. This manual provides information about how to set up and operate your printer, load media, ribbon and solve common problems. Illustrations are provided to help you quickly become familiar with the printer.

1.1 Features



- **Various Connectivity Options:** Ethernet, due USB host, USB device.
- **Easy Operation:** One-button design for easy control
- **Fast Print Speed:** Max 7 inches/sec for the O4 model
- **Wireless LAN Connection:** Build a Wireless LAN printing environment with Bluetooth
- **External Memory:** The extra USB port allows you to use a USB flash drive for storage

1.2 Unpacking

Make sure all of the following items are included in your package.



ARGOX O4 Printer

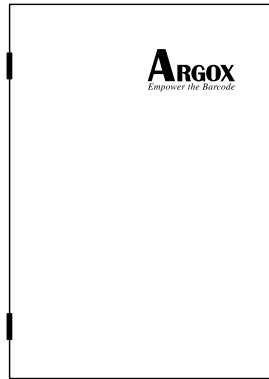

Quick Installation Guide

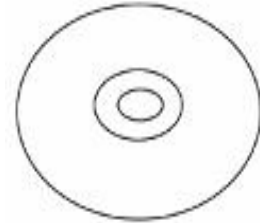

DVD

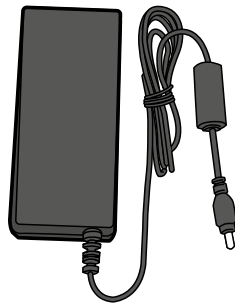

Power Supply



AC Power Cord

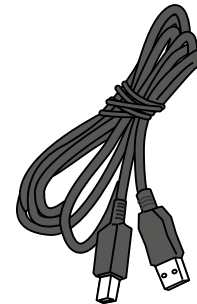

USB Cable

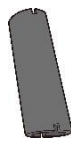

Ribbon Core (0.5 inch)

When you receive the printer, open the package immediately and inspect for shipping damage. If you discover any damage, contact the shipping company and file a claim. ARGOX is not responsible for any damage incurred during shipping. Save all package materials for the shipping company to inspect.



Note If any item is missing, please contact your local dealer.

1.3 Understand your printer

1.3.1 Perspective view

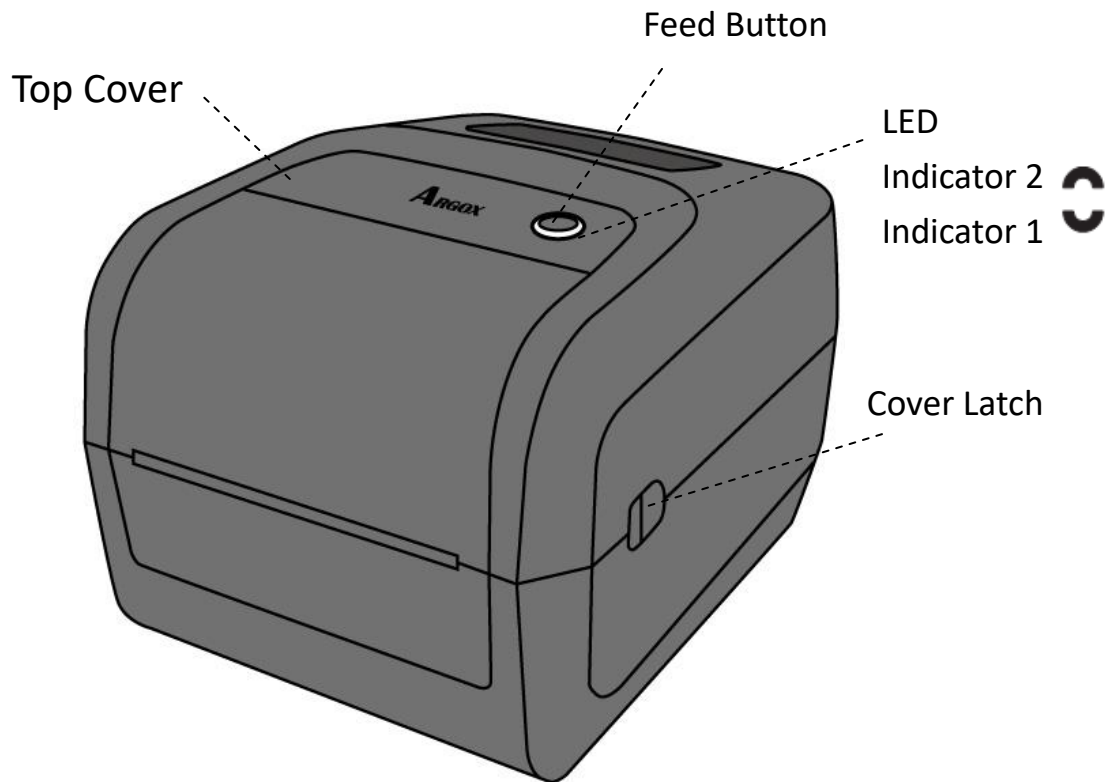

1.3.2 Back view

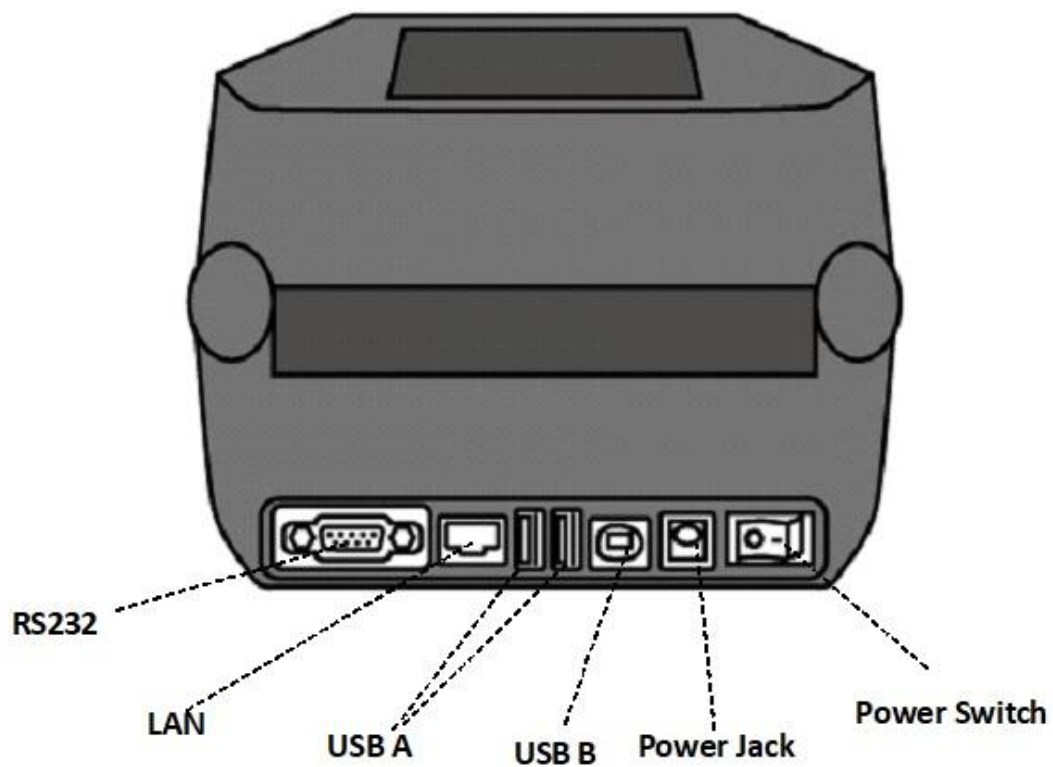

Caution To avoid injury, be careful not to trap your fingers in the Paper Slot while opening or closing the Top Cover.

1.3.3 Interior view I

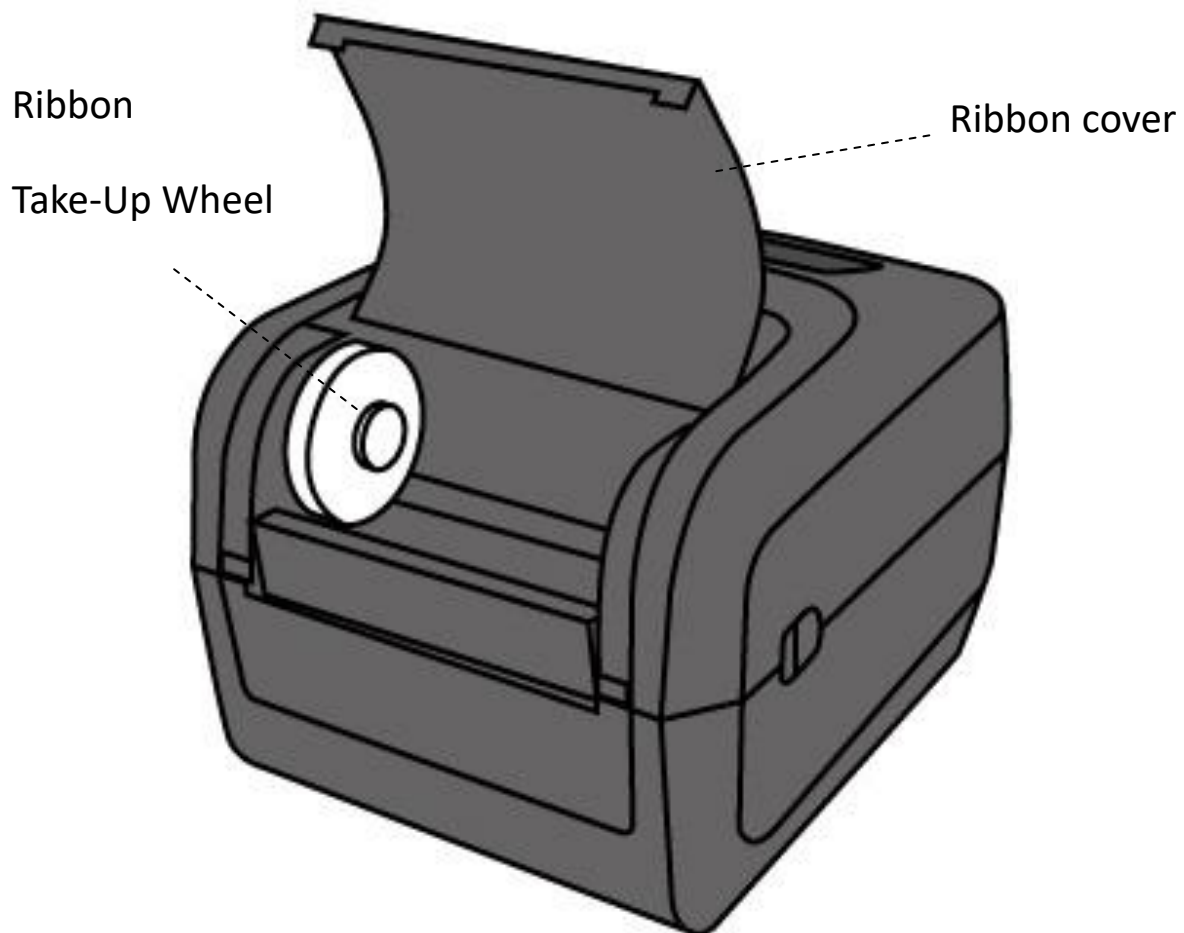

1.3.4 Interior view II

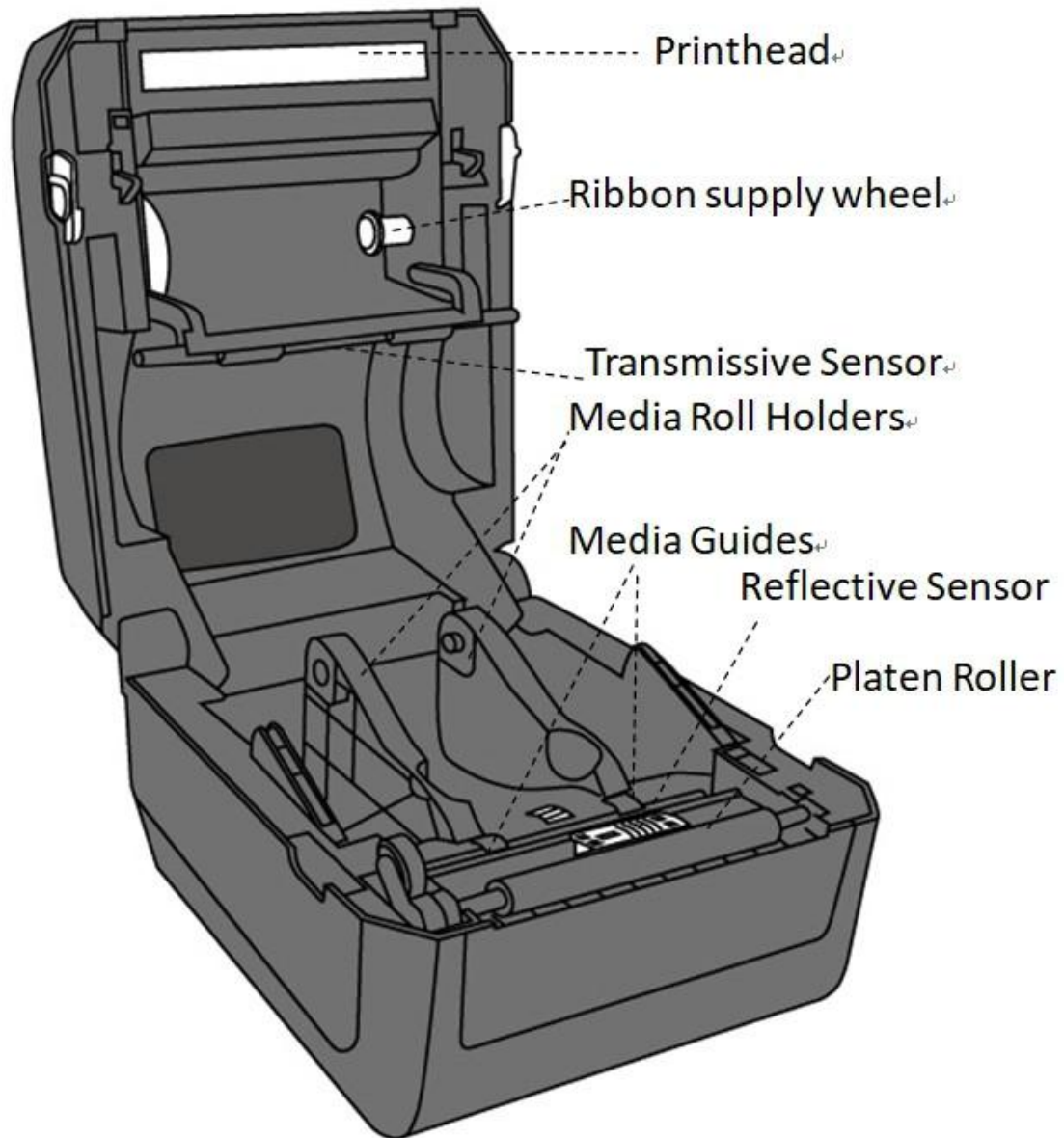

Warning The printhead becomes very hot during printing. Do not touch the printhead or touch around it directly after printing. By doing so you may get burnt.

1.4 Printer lights

There are two LED lights that show the status of O4 Series printer. The Upside light is defined in LED2. LED1 is downside between LED2 and Feed symbol.

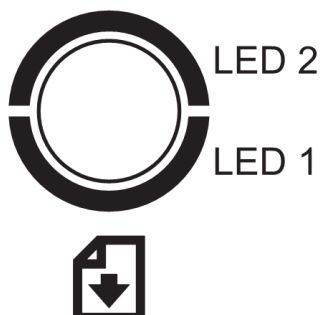









1.4.1 Status lights



Status lights help you check printer's condition. The following tables show the blinking speed of status lights and the conditions they indicate.

LED image	Blinking Speed	Blinking Interval
	lighting	Always on
	Slow	0.8 Seconds
	Fast	0.2 Second

LED image	Blinking Pattern description
	Alternate blinking.
	Blinking at the same time.

Blinking pattern	LED 2	LED 1	Description
	Green	Green	The printer is ready to print.
	Green	Green	In pause.
	Green	Green	The printer is transmitting data.
	Green	Green	TPH high temperature.
	Green	Green	The printer is writing data to the flash or USB memory. The USB memory is being initialized.
	Amber	Amber	Paper jam. The media is out when the print data sent to the printer. Paper end.
	Amber	Amber	Ribbon end or ribbon error. (for thermal transfer models)
	Red	Red	H/W Error
			The printhead is broken.
			Communication error (RS-232C).
			Cutter error (with optional cutter).
	Red	Red	Command error
			The RTC battery is low. (If the printer has a built-in RTC)
			An EEPROM for backup cannot be read or written properly.
			A command has been fetched from an odd address.
			Word data has been accessed from a place other than the boundary of the word data.
			Long word data has been accessed from a place other than the boundary of the long word data.

1 Introduction

				Command error.
	Red	Red	Top Cover open	<p>The print module is opened when the printer is turned on.</p> <p>Cover (Thermal Head) open error during printing.</p>
	Red	Red	USB r/w error	<p>Flash ROM on the CPU board error or USB memory error.</p> <p>An erase error has occurred when formatting the USB memory.</p> <p>Unable to save files due to insufficient USB memory.</p>

1.4.2 System mode

The system mode consists of status light color combinations. It contains a list of commands for you to select and run.

To enter the system mode and run the command, do the following:

1. Turn off the printer.
2. Press and hold the **FEED** button, and turn on the printer.
3. Both status lights glow solid amber for a few seconds. Next, they turn to green shortly, and then turn to other colors.
4. When status lights show the color combination you need, release the **FEED** button immediately.
5. Press the **FEED** button to run the command.

The following table is the command list of the system mode.

LED 2	LED 1	Command
Red	Green	Transmissive Sensor Calibration (Section 3.1)
Amber	Green	Reflective Sensor Calibration (Section 3.1)
Red	Red	Resetting Your Printer (Section 3.3)
Amber	Red	Reserved
Green	Red	Disable Checking RTC Battery Charge
Red	Amber	Reserved
Green	Amber	Self Test (Section 3.2)

2 Get started

This chapter describes how to set up your printer.



Caution Do not use your printer in areas exposed to splashing water or any other liquid.



Caution Do not drop your printer, or place it in an area subject to humidity, vibration or shock.

2.1 Attach the power cord

1. Make sure the power switch is set to the **OFF** position.
2. Insert the power supply's connector into the printer power jack.
3. Insert the AC power cord into the power supply.
4. Plug the other end of the AC power cord into the wall socket.

Important Use only power supplies listed in the user instructions.

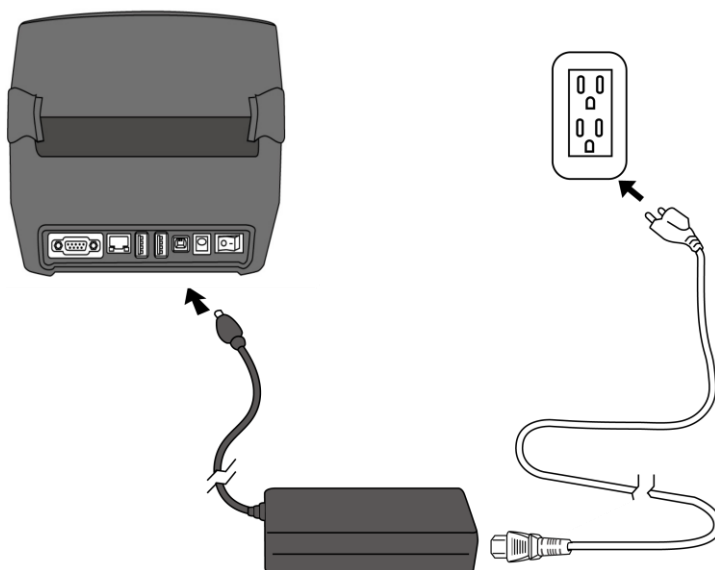

Warning Do not plug the AC power cord with wet hands, or operate the printer and the power supply in an area where they may get wet. Serious injury may result from these actions!

2.2 Turn on/off your printer

When your printer is connected to a host (a computer), it is good to turn on the printer before turning on the host, and turn off the host before turning off the printer.

2.2.1 Turn on your printer

1. To turn on your printer, turn on the **Power Switch** as below. The “I” is the **ON** position.

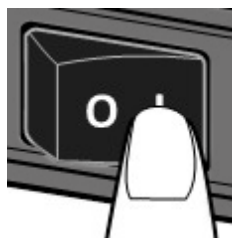

2. Both status lights glow solid amber for a few seconds, then turns to solid green.



Note If you connect the printer to the internet or insert a USB drive before turning on the printer, it will take longer for the printer to enter the online mode after you turn it on.

2.2.2 Turn off your printer

1. Make sure LED is solid green before turning off the printer.
2. To turn off your printer, turn off the **Power Switch** as below. The “O” is the **OFF** position.

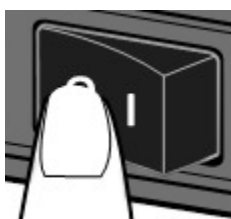

Caution Do not turn off your printer during data transmission.

2.3 Load media

There are various types and sizes for the media roll. Load the applicable media to satisfy your need.

2.3.1 Prepare media

The inside wound and outside wound media roll can be loaded into the printer the same way. In case the media roll is dirty during shipping, handling or storage, remove the outside length of the media. It helps avoid dragging adhesive and dirty media between the printhead and platen roller.

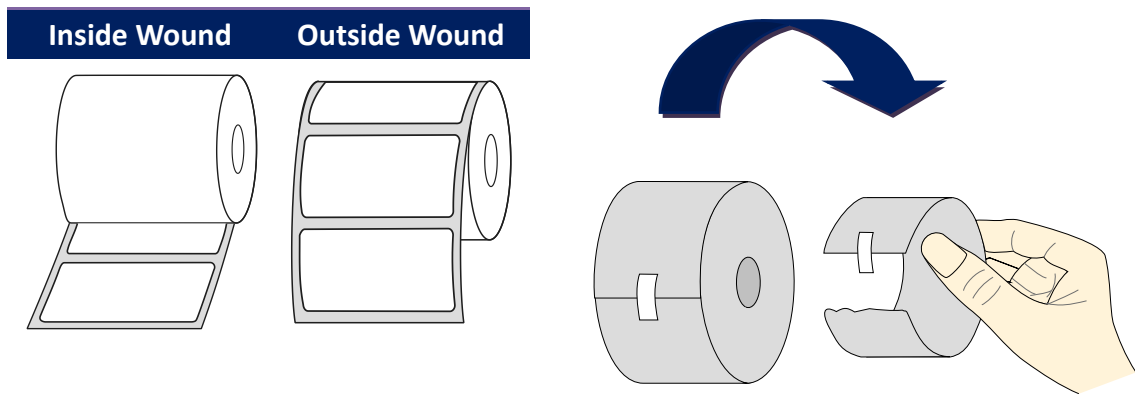

2.3.2 Place a media roll

1. Pull the head latch to open the top cover of the printer.



2. Pull the **Media Roll Holders** to slide them outward, and place the media roll between the holders. Make sure the print side is up, and the media roll is clamped tightly by the holders.

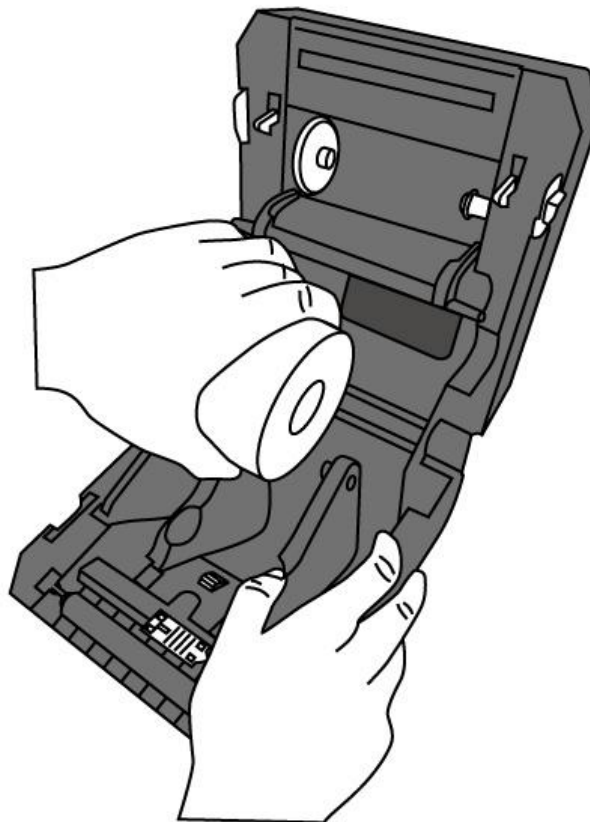

2 Get started

3. Pull the media until it reaches out of the printer. Thread the media under the media guides.

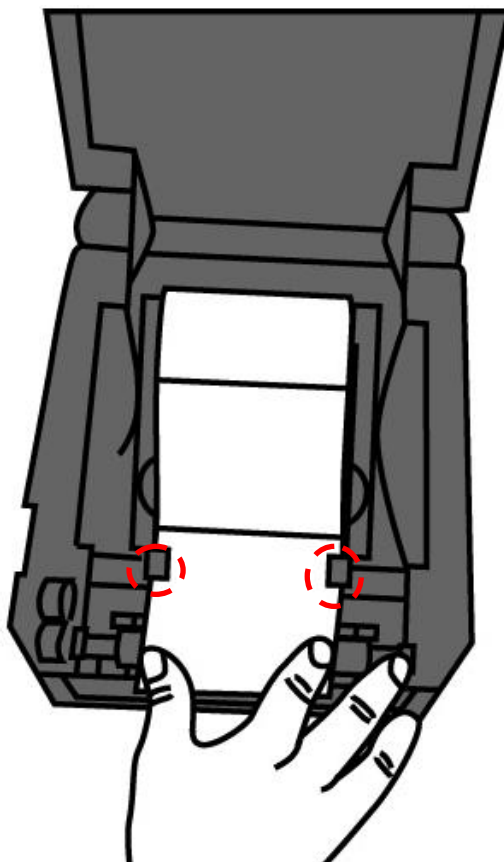

4. Close the top cover on both side.

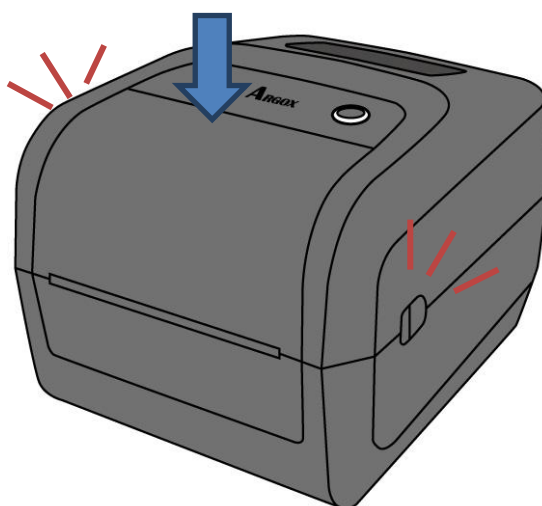

Flexibility

If you usually use the same width media or fanfold media, scroll the “Media Roll Holder Wheel” to adjust width to the same media guide.

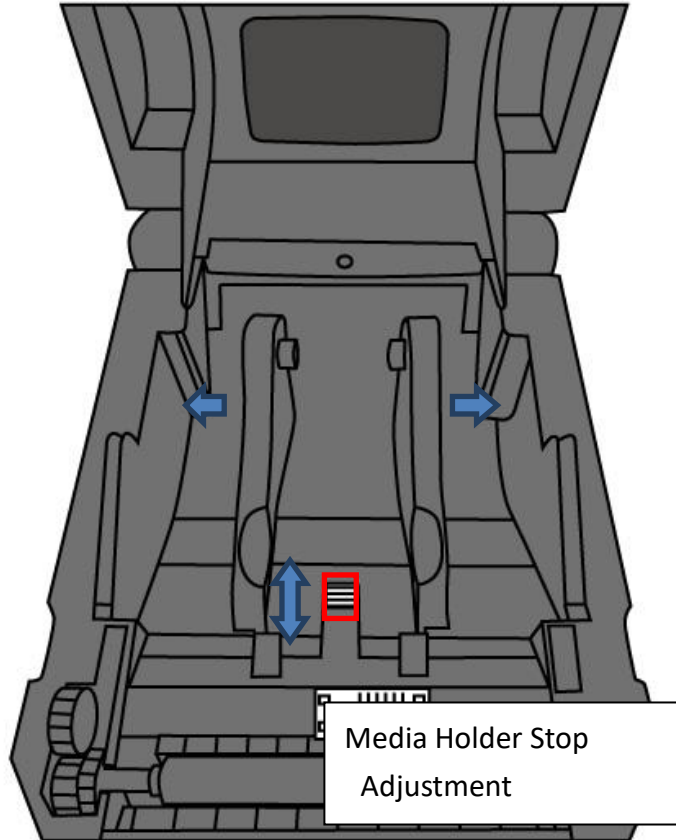

2.3.3 Test media feed

1. Turn on the printer, and press the **FEED** button to feed a label.

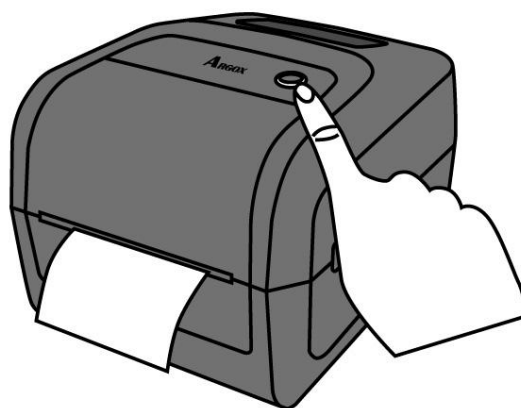



2. Flip the media and tear it along the edge of the front cover.

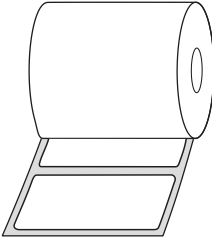
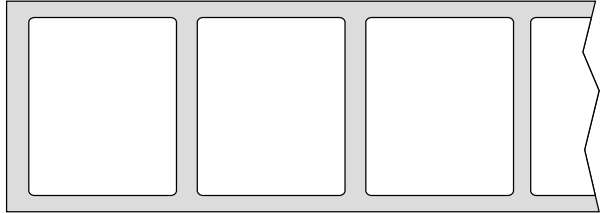
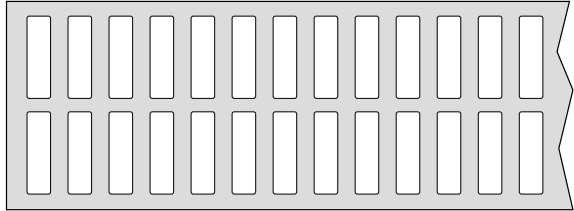
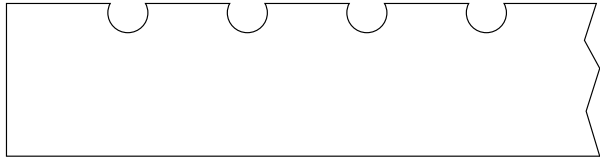

2.4 Media types

Your printer supports various media types, including non-continuous media, continuous media, and fanfold media. The following table provides details about them.

Media Type	Looks Like	Description
<p>Non-Continuous Media</p>	     	<p>Non-continuous media is the typical media for bar code printing. Labels and tags are made of various materials, such as paper, fabric or cardstock, and are separated by gaps, holes, notches or black marks. Many labels are self-adhesive with liners, while some are linerless.</p>

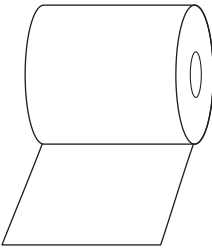
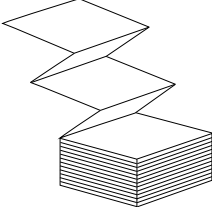
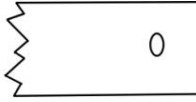
Media Type	Looks Like	Description
<p>Continuous Media</p>		<p>Continuous media does not have gaps, holes, notches or black marks. It allows you to print data anywhere on the media. A cutter may be used for splitting labels.</p>
<p>Fanfold Media</p>		<p>Fanfold media is in continuous form, but it can be used as non-continuous media, because its labels are separated by folds. Some fanfold media also has black marks or liners.</p>
<p>Tag Media</p>		<p>Tag media is usually made from a heavy paper, with central hole to index. It does not have adhesive or a liner, and it is typically perforated between tags. The media may also have black marks or other separations</p>

2.5 Placing Ribbon Roll

1. Open the top cover of the printer.



2. Do the following to install both rolls:

- To load the supply roll, put the core on the right side and press the roll to the supply hub, and then align the left side of the notch to the left side take-up hub.

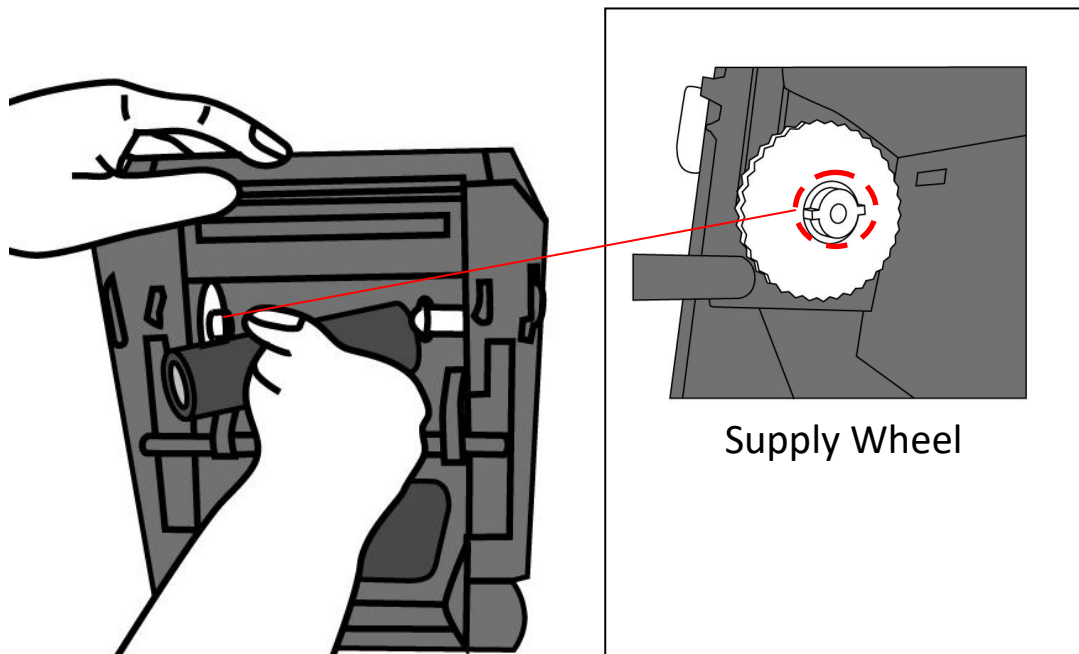

2 Get started

- Open take-up supply cover. To load the take-up roll, align the core on the right side and press the roll to the right take-up hub, and then put the left side of the roll to the left side take-up hub.

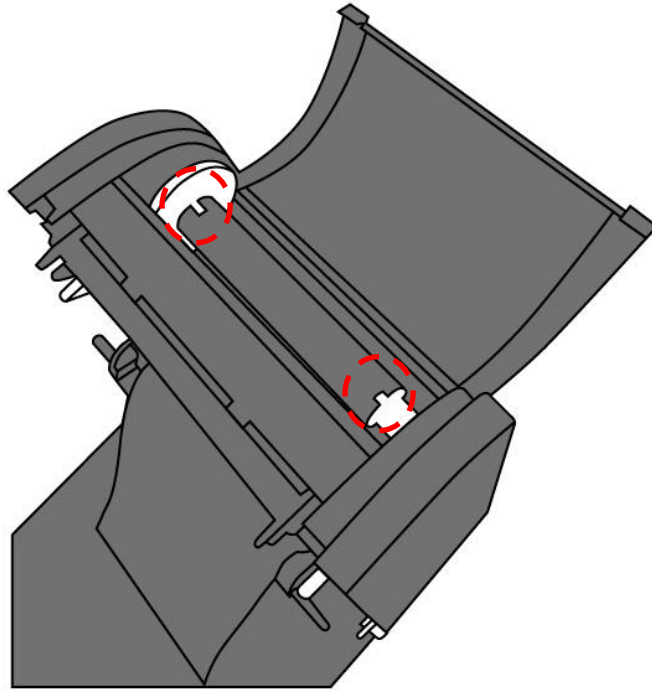

Note Make sure both supply and take-up roll are matched correctly with notches. Rotate the roll with wheel can help the roll match notches when you hear a “click” sound.

3. Pull the ribbon from the supply roll and tape it on the take-up roll.

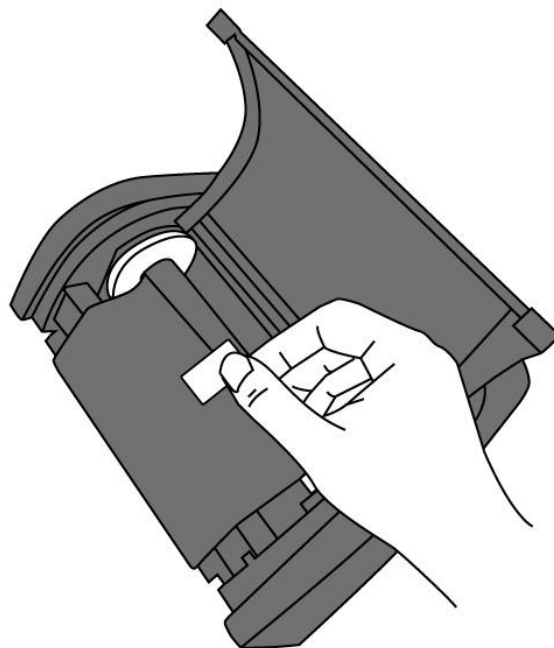

4. Rotate the **Take-Up Wheel** to straighten the ribbon and reduce its wrinkles.

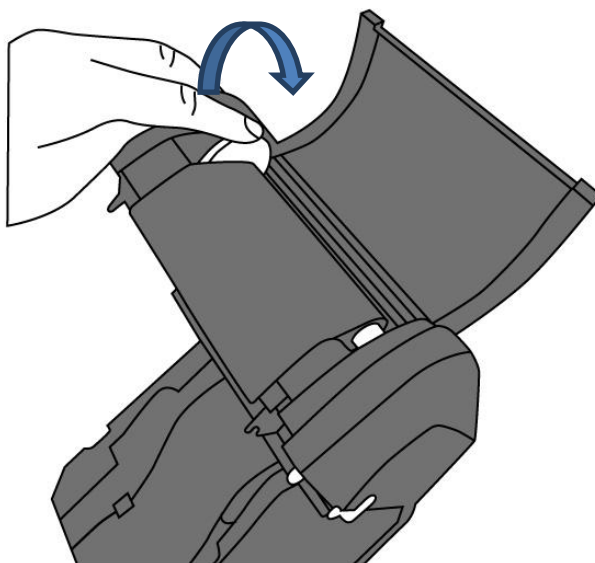

5. Close the printer module and press down firmly at its both sides, until you hear a click.



Note For the supply hub, the ribbon wind direction can be coated side in (CSI) or coated side out (CSO); for the take-up hub, the wind direction must be CSO.

2.6 Media sensing

O4 printers offer two types of media sensor: transmissive and reflective. They are used for detecting specific media types.

2.6.1 Transmissive sensor

The transmissive sensor is fixed and placed near the center line with 6.27 mm offset of the printhead. It is used for detecting gaps across the entire width of the label.

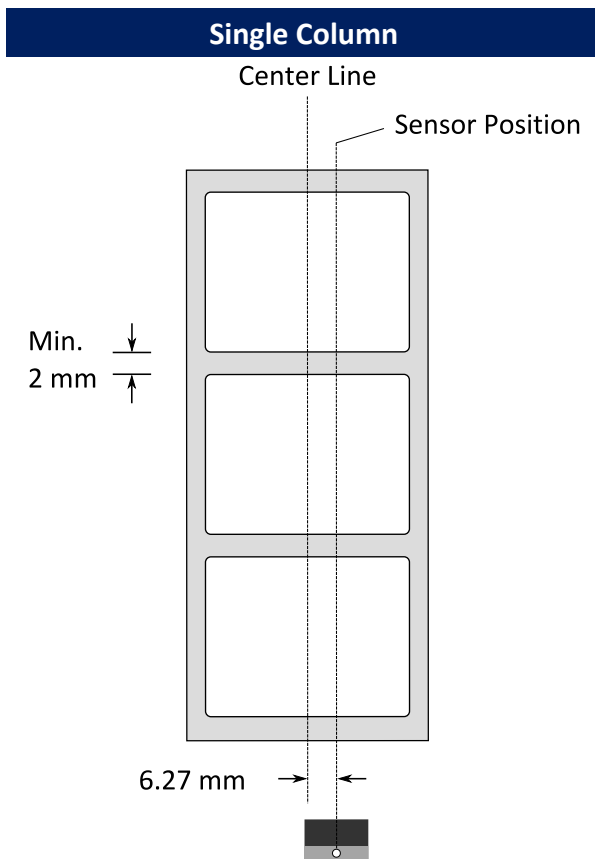

2.6.2 Reflective sensor

The reflective sensor is movable within the entire width of the media. It detects gaps, notches and black marks not located at the center of the media.

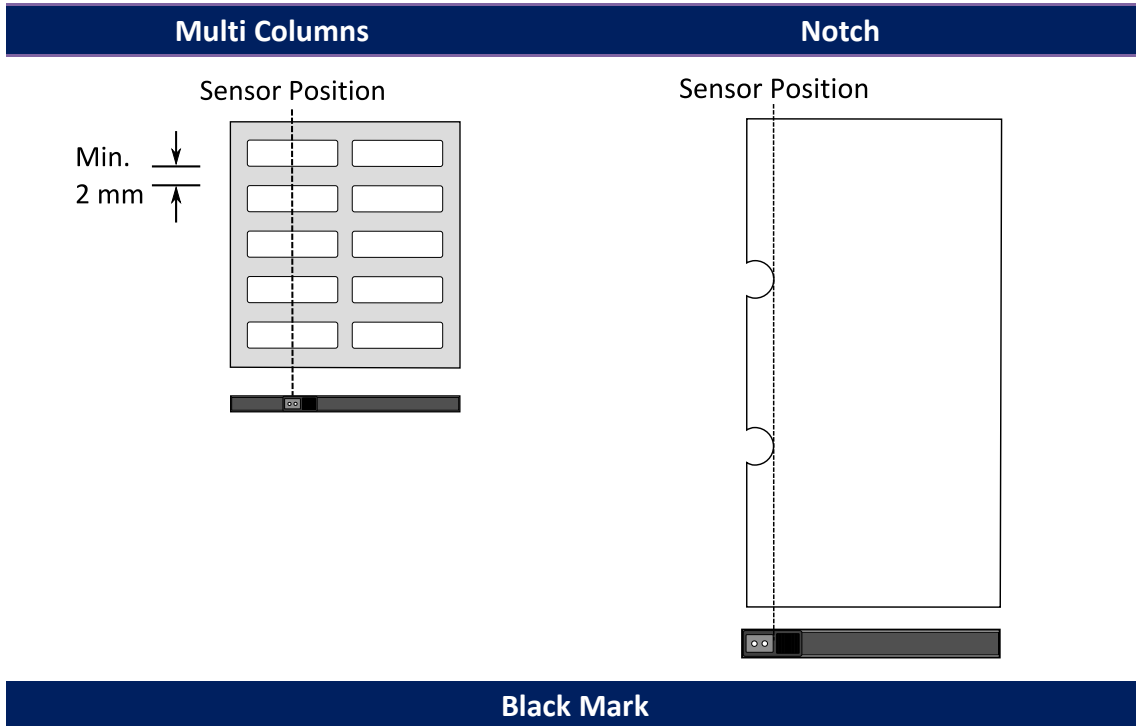

Black Mark

Flip the media so the black-mark side is facing down to align with the sensor.

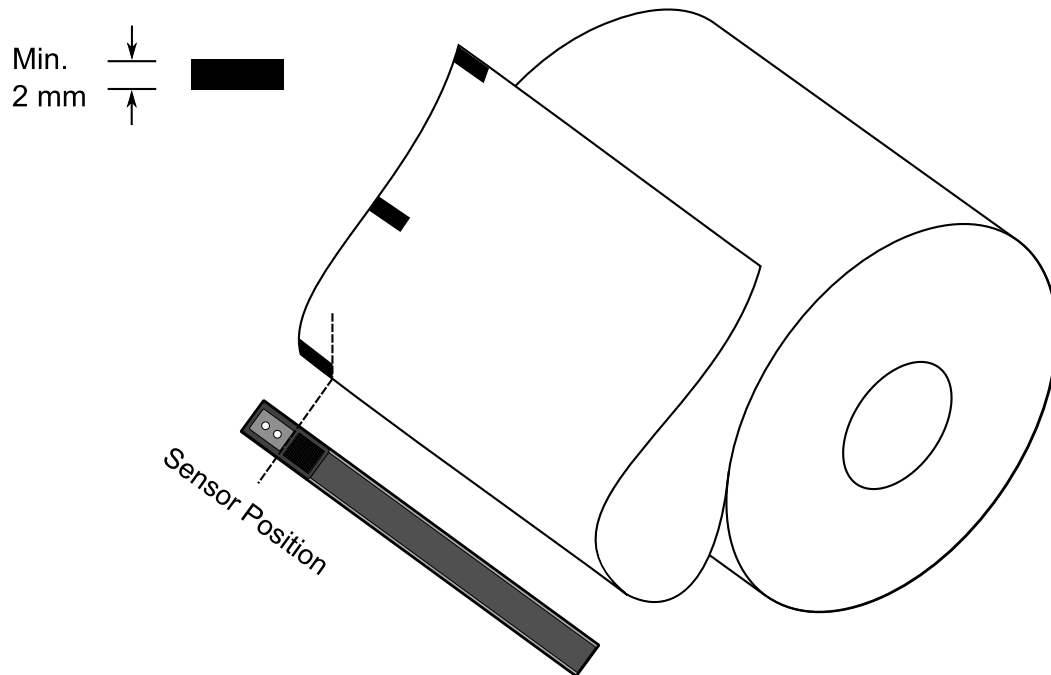

3 Printer operation

This chapter provides information about printer operation.

3.1 Printing Media Calibration & Configuration

You will want the printer to work properly before starting your print jobs. To do this, you need to calibrate the media sensor. Printers provide transmissive and reflective sensor calibration. Take the following steps to use them.

1. Make sure the media is properly loaded, the print module is closed, and the printer's power switch is set to the **OFF** position.
2. Press and hold the **FEED** button, and turn on the printer.
3. Both status lights glow solid amber for a few seconds. Next, they turn to green shortly, and then turn to other colors. Do one of the following to select the sensor:
 - If you want to calibrate the transmissive sensor, when LED 2 turns to red and LED 1 turns to green, release the **FEED** button immediately.
 - If you want to calibrate the reflective sensor, when LED 2 turns to amber and LED 1 turns to green, release the **FEED** button immediately.
4. Press the **FEED** button. The media calibration is complete after the printer feeds 3-4 labels and stops.

3.2 Self-test

The printer can run a self test to print a configuration label, which helps you understand current settings of the printer.

1. Turn off the printer.
2. Press and hold the **FEED** button, and turn on the printer.
3. Both status lights glow solid amber for a few seconds. Next, they turn to green shortly, and then turn to other colors. When LED 2 turns to green and LED 1 turns to amber, release the **FEED** button.
4. Press the **FEED** button to print a configuration label.

Your configuration label should look like this:

3 Printer operation

PPLZ

```

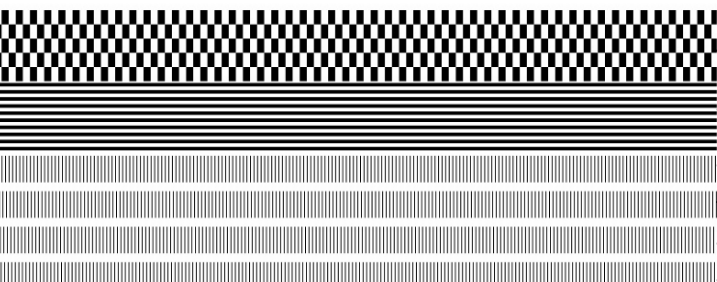
LABEL PRINTER WITH FIRMWARE
04-250-V01.02 20170502 PPLZ _____ 1
STANDARD RAM : 32M BYTES _____ 2
AVAILABLE RAM : 3676K BYTES _____ 3
FLASH TYPE : ON BOARD 16M BYTES _____ 4
AVAILABLE FLASH : 8528K BYTES _____ 5
NO. OF DL SOFT FONTS(FLASH) : 0 _____ 6
NO. OF DL SOFT FONTS(RAM) : 0 _____ 7
NO. OF DL SOFT FONTS(HOST) : 0 _____ 8
H. POSITION ADJUST.: 001A _____ 9
SEE-THRU-2 SENSOR _____ 10
REF: 0162 SEE2: 0037 _____ 11
RTC TIME: 1/1/0(2:3:37) _____ 12
MAX LABEL HEIGHT: 98 INCHES _____ 13
PRINT WIDTH: 812 DOTS _____ 14
LAB LEN(TOP TO TOP): 78mm _____ 15
SPEED: 3 IPS _____ 16
ABS. DARKNESS: 16 _____ 17
TRIM. DARKNESS: 0 _____ 18
THERMAL TRANSFER _____ 19
PRINT LENGTH: 38M _____ 20
CUT COUNT:0 _____ 21
RS232: 9600, 8, N, 1P, XON/XOFF _____ 22
CARET CONTROL CHAR : <^> 5EH _____ 23
DELIMITER CONTROL CHAR : <.> 2CH _____ 24
TILDE CONTROL CHAR : <~> 7EH _____ 25
CODE PAGE : USA1 _____ 26
MEDIA : CONTINUOUS _____ 27
CALIBRATION MODE: INTELLI PRINT _____ 28
REPRINT AFTER ERROR : ENABLED _____ 29
BACKFEED DISABLED _____ 30
CUTTER DISABLED _____ 31
PEELER DISABLED _____ 32
CUTTER/PEELER OFFSET: 0 <+-0.01mm> _____ 33
IP ADDRESS: 0.0.0.0 _____ 34
SUBNET MASK: 0.0.0.0 _____ 35
GATEWAY: 0.0.0.0 _____ 36
MAC ADDRESS: 00-00-00-00-00-00 _____ 37
DHCP: ENABLED _____ 38
DHCP CLIENT ID: FFFFFFFFFFFFFFFF _____ 39
                    FFFFFFFFFFFFFFFF
DHCP HOST NAME: _____ 40
SNMP: ENABLED _____ 41
SOCKET COMM.: ENABLED _____ 42
SOCKET PORT: 9100 _____ 43
IPV6 MODE: MANUAL _____ 44
IPV6 TYPE: NONE _____ 44
IPV6 ADDRESS: 0000:0000:0000:0000: _____ 45
                0000:0000:0000:0000
LINK LOCAL : 0000:0000:0000:0000: _____ 46
                0000:0000:0000:0000
PRODUCT SN: 0000000001 _____ 47
USB SN: 0000000001 _____ 48
CG ENABLED _____ 49
ot(0,0)<0.1dot,0.01mm> _____ 50
rm(0,0)<1+ 0-,0.01mm> _____ 51
sm(0,0)<1+ 0-,0.01mm> _____ 52
rv(243,176,67)<0.01u><P> _____ 53
sv(291,144,146)<0.01u><P> _____ 54
bv(312,42,270)<0.01u><P> _____ 55
rso(0)<0.01mm> _____ 56
sso(-130)<0.01mm> _____ 57
sagc(237)<0.01u><P> _____ 58
THIS IS FONT A. 0123ABCabc _____ 59
THIS IS FONT B. 0123ABCabc _____ 60
THIS IS FONT C. 0123ABCabc _____ 61
THIS IS FONT D. 0123ABCabc _____ 62
THIS IS FONT E. 0123ABCabc _____ 63
THIS IS FONT F. 0123ABCabc _____ 64
THIS IS FONT G. _____ 65
THIS IS FONT H. 0123ABC _____ 66
This Is Font CG Triumv Bd Condensed. _____ 67

_____ 68
_____ 69
_____ 70
_____ 71
_____ 72
_____ 73

```

1. Version Information

The firmware version and its build date.

2. Standard RAM

Total SDRAM size.

3. Available RAM

RAM is able to be used.

4. Flash Type

The flash memory type and size.

5. Available Flash

Flash is able to be used.

6. No of DL soft fonts (FLASH)

The number of fonts is downloaded in Flash.

7. No of DL soft fonts (RAM)

The number of fonts is downloaded in RAM.

8. No of DL soft fonts (HOST)

The number of fonts is downloaded in USB HOST.

9. H. Position Adjust

Move the print position horizontally.

10. Sensor Type

The media sensor type such as reflective sensor.

11. Label-less Calibration Value

Check if a label-less calibration has been performed on the printer. If not, the value is 0000.

12. RTC Time

The date and time of the real-time clock (RTC). The default format is month/day/year (hour:minute:second). If your printer has a built-in RTC, the RTC time shows here.

13. Max Label Height

The max label length you can print at a time. For 200 dpi models, it is 100 inches; for 300 dpi models, it is 50 inches.

14. Print Width

The print width in dots.

15. Lab Len (Top to Top)

For non-continues media, it is the length between the tops of two labels.

16. Speed

The speed of printing. The unit is inch per second (ips).

17. ABS. Darkness

The current darkness. You can use the PPLZ command ~SD to define it.

18. Trim. Darkness

The adjustment of the current darkness. You can use the PPLZ command ^MD to define it.

19. Print Method

It is either thermal transfer (TT) or direct thermal (DT) printing. TT requires ribbons and DT doesn't.

20. Print Length

The total print length.

21. Cut Count

It counts the times the cutter cuts.

22. RS232 Protocol

It lists RS-232C settings in the following order: baud rate, data length, parity check, stop bit and flow control.

23. Caret Control Char

The control character your printer is using.

24. Delimiter Control Char

The control character your printer is using.

25. Tilde Control Char

The control character your printer is using.

26. Code page

The character set table.

27. Media

The media type in use.

28. Calibration mode

There are intelli mode or smart mode.

Intelli mode: Just install labels, latch print module, press FEED button once, and then the printer will feed 1-2 labels to detect next gap / black mark before printing. The printer will feed 1-2 labels automatically before printing, if FEED button is not pressed.

Smart mode: Print from the first label immediately according to label length setting. Make sure to carefully align label bottom edge at the tear-off position before printing.

29. Reprint After Error

When it is enabled, your printer reprints the label after the error fixed if it is printed incorrectly due to the error.

30. Backfeed Enabled/Disabled

Enable or disable backfeed during the printing process. When it is enabled, the printer moves the paper forward in a predefined length 1 second after printing, and pulls the paper back in a predefined length once the printing begins again. When it is disabled, the printer won't move the paper at all.

31. Cutter Enabled/Disabled

Enable or disable the cutter during the printing process.

32. Peeler Enabled/Disabled

Enable or disable the dispenser during the printing process.

33. Cutter/Peeler Offset

Move the cutting line or the peeling position forward or backward. The value in the angle brackets is the offset unit.

34. IP Address

The static IP address of the printer. The default value is "192.168.1.1".

35. Subnet Mask

The manually specified subnet mask of the printer. The default value is "255.255.255.0."

36. Gateway

The manually specified gateway of the printer. The default value is "0.0.0.0."

37. MAC Address

The unique address assigned to the printer that connects to the internet.

38. DHCP

When DHCP is enabled, it assigns an IP address to the printer automatically.

39. DHCP Client ID

It is an arbitrary value sent to the DHCP server to reserve an IP address for the printer.

40. DHCP Host Name

The name of a DHCP client.

41. SNMP

When it is enabled, the host gets or sets parameters registered as SNMP entities.

42. Socket Communication

When it is enabled, the host communicates with the printer via the socket.

43. Socket Port

The socket number of the printer.

44. IPv6 Mode

It determines how you get the IPv6 address of your printer. There are three modes: MANUAL, DHCPv6 or AUTO.

45. IPv6 Type

It is the IPv6 address type of your printer. There are four types: NONE, NORMAL, EUI and ANY.

46. IPv6 Address

The static IPv6 address of your printer.

47. Link Local

The IPv6 address that used in a network segment. It is allocated automatically.

48. Product SN

The serial number of product.

49. USB SN

The Serial number of USB host.

50. CG Enable

Printer is able to use True Type font.

51. TPH and Cutter Offset

For developers to debug.

52. Reflective Sensor Gap Calibration

For developers to debug.

53. See-Through Sensor Gap Calibration

For developers to debug.

54. Reflective Sensor Profile

For developers to debug.

55. See-Through Sensor Profile

3 Printer operation

For developers to debug.

56. Ribbon Voltage Delta

For developers to debug.

57. Reflective Sensor Offset

For developers to debug.

58. See-Through Sensor Offset

For developers to debug.

59. See-Through Sensor Automatic Gain Control

For developers to debug.

60-68. Font Image

You can use them as the reference to check your label font.

69-74. TPH Test Pattern

You can use them to check broken pins on the printhead.

If your printer has a Wi-Fi module, your PPLZ configuration label will contain the following entries:

```
WLAN FW VERSION: 1.00 _____ 1
                  DATE: 2015.05.26 _____ 2
WLAN IP ADDRESS: 0.0.0.0 _____ 3
WLAN SUBNET MASK: 0.0.0.0 _____ 4
WLAN GATEWAY: 0.0.0.0 _____ 5
WLAN MAC ADDRESS: 00-80-92-4F-77-35 _____ 6
WLAN DHCP: AUTO _____ 7
WLAN DHCP HOSTNAME: 00-80-92-4F-77-3 _____ 8
                   : 5
WLAN SOCKET PORT: 9100 _____ 9
WLAN SSID: WIRELESS PRINTER _____ 10
WLAN MODE: Infrastructure _____ 11
WLAN COUNTRY CODE: USA _____ 12
WLAN CHANNEL: AUTO _____ 13
WLAN NETWORK AUTHENTICATION: Open _____ 14
WLAN WEP: OFF _____ 15
```

1. FW Version

WLAN board firmware version.

2. Date

WLAN board firmware version date.

3. IP Address

The IP address of your printer. When DHCP is enabled, it shows the automatically assigned IP address; when DHCP is disabled, it shows the manually specified IP address.

4. Subnet mask

The netmask of your printer. When DHCP is enabled, it shows the automatically assigned netmask; when DHCP is disabled, it shows the manually specified netmask.

5. Gateway

The gateway of your printer. When DHCP is enabled, it shows the automatically assigned gateway; when DHCP is disabled, it shows the manually specified gateway.

6. Mac address

The unique address assigned to your printer that connects to the internet.

7. DHCP

When DHCP is enabled, it assigns an IP address to your printer automatically.

8. DHCP Hostname

The name of a DHCP client.

9. Socket Port

The socket number of the printer.

10. SSID

Short for service set identifier. It is the name of a wireless local area network.

11. Mode

There are ad-hoc and infrastructure mode. Refer to Print Tool Network type description from Technical manual.

12. Country Code

The country or region.

13. Channel

The Wi-Fi channel.

14. Network Authentication

There are six mode. Refer to Printer Tool Network authentication description from Technical manual.

15. WEP

Refer to Printer Tool Wep description from Technical manual.

3 Printer operation

PPLA

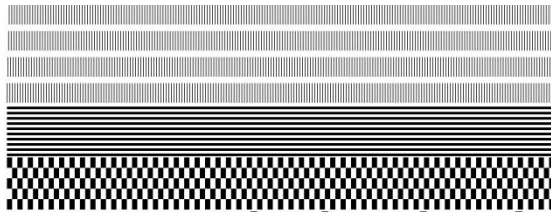

R8/E94/PC/PCA/PCB/LG/

Courier Fonts:

ASD Smooth font (18 points) - 12

ASD Smooth font (14 points) - 123456789

ASD Smooth font (12 points) - 123456789 ABCa

ASD Smooth font (10 points) - 123456789 ABCabcXyz

ASD Smooth font (8 points) - 123456789 ABCabcXyz

ASD Smooth font (6 points) - 123456789 ABCabcXyz

123456789

This is internal font 7. 0CR-A ABCabc

THIS IS INTERNAL FONT

THIS IS INTERNAL FONT 5. 012345678

THIS IS INTERNAL FONT 4. 012345678

THIS IS INTERNAL FONT 3. 0123456789 ABCABC

This is internal font 2. 0123456789 ABCabcXyz

This is internal font 1. 0123456789 ABCabcXyz

saSc(237)<0.01u><P>

sso(-130)<0.01mm>

rso(0)<0.01mm>

bu(312.42,270)<0.01u><P>

sv(291.144,146)<0.01u><P>

rv(243.176,67)<0.01u><P>

sm(0,0)<1+ 0-.0.01mm>

rm(0,0)<1+ 0-.0.01mm>

ot(0,0)<0.1dot.0.01mm>

CG ENABLED

USB SN: 000000000001

PRODUCT SN: 000000000001

0000:0000:0000:0000

LINK LOCAL : 0000:0000:0000:0000:

0000:0000:0000:0000:

IPV6 ADDRESS: 0000:0000:0000:0000:

IPV6 TYPE: NONE

IPV6 MODE: MANUAL

SOCKET PORT: 9100

SOCKET COMM.: ENABLED

SNMP: ENABLED

DHCP HOST NAME:

FFFFFFFFFFFFFFFF

DHCP CLIENT ID: FFFFFFFFFFFFFFFFFF

DHCP: ENABLED

MAC ADDRESS: 00-00-00-00-00-00

GATEWAY: 0.0.0.0

SUBNET MASK: 0.0.0.0

IP ADDRESS: 0.0.0.0

CUTTER/PEELER OFFSET: 0 <+-0.01mm>

PEELER DISABLED

CUTTER DISABLED

BACKFEED DISABLED

CALIBRATION MODE: INTELLI PRINT

MEDIA: CONTINUOUS

STD CTRL. CODES

CODE PAGE: PC-850

RS232: 9600,8,N,1P,XON/XOFF(SOFTWARE)

CUT COUNT: 0

PRINT LENGTH: 38M

THERMAL TRANSFER

DARKNESS: 10

SPEED: 3 IPS

LAB LEN(TOP TO TOP): 78mm

PRINT WIDTH: 801 DOTS

MAX LABEL HEIGHT: 98 INCHES

RTC TIME: 1/1/0(2:5:29)

REF: 0162 SEE2: 0037

SEE-THRU-2 SENSOR

H. POSITION ADJUST.: 001A

NO. OF DL SOFT FONTS(HOST): 0

NO. OF DL SOFT FONTS(RAM): 0

NO. OF DL SOFT FONTS(FLASH): 0

AVAILABLE FLASH: 8528K BYTES

FLASH TYPE: ON BOARD 16M BYTES

AVAILABLE RAM: 3676K BYTES

STANDARD RAM: 32M BYTES

04-250-V01.02 20170502 PPLA

LABEL PRINTER WITH FIRMWARE

3 Printer operation

PPLB

```

LABEL PRINTER WITH FIRMWARE
04-250-V01.02 20170502 PPLB
STANDARD RAM : 32M BYTES
AVAILABLE RAM : 3676K BYTES
FLASH TYPE : ON BOARD 16M BYTES
AVAILABLE FLASH : 8528K BYTES
NO. OF DL SOFT FONTS(FLASH) : 0
NO. OF DL SOFT FONTS(RAM) : 0
NO. OF DL SOFT FONTS(HOST) : 0
H. POSITION ADJUST.: 001A
SEE-THRU-2 SENSOR
REF: 0162 SEE2: 0037
RTC TIME: 1/1/0(2:42:11)
MAX LABEL HEIGHT: 98 INCHES
PRINT WIDTH: 801 DOTS
LAB LEN(TOP TO TOP): 78mm
SPEED: 3 IPS
DARKNESS: 8
THERMAL TRANSFER
PRINT LENGTH: 38M
CUT COUNT:0
RS232: 9600, 8, N, 1P, XON/XOFF
CODE PAGE : English (437)
MEDIA : CONTINUOUS
CALIBRATION MODE: INTELLI PRINT
BACKFEED DISABLED
CUTTER DISABLED
PEELER DISABLED
CUTTER/PEELER OFFSET: 0 <+--0.01mm>
IP ADDRESS: 0.0.0.0
SUBNET MASK: 0.0.0.0
GATEWAY: 0.0.0.0
MAC ADDRESS: 00-00-00-00-00-00
DHCP: ENABLED
DHCP CLIENT ID: FFFFFFFFFFFFFFFF
                FFFFFFFFFFFFFFFF
DHCP HOST NAME:
SNMP: ENABLED
SOCKET COMM.: ENABLED
SOCKET PORT: 9100
IPV6 MODE: MANUAL
IPV6 TYPE: NONE
IPV6 ADDRESS: 0000:0000:0000:0000:
              0000:0000:0000:0000
LINK LOCAL   : 0000:0000:0000:0000:
              0000:0000:0000:0000
PRODUCT SN: 00000000001
USB SN: 000000000001
CG ENABLED
ot(0,0)<0.1dot,0.01mm>
rm(0,0)<1+ 0-,0.01mm>
sm(0,0)<1+ 0-,0.01mm>
rv(243,176,67)<0.01v><P>
sv(291,144,146)<0.01v><P>
bv(312,42,270)<0.01v><P>
rso(0)<0.01mm>
sso(-130)<0.01mm>
sagc(237)<0.01v><P>
This is internal font 1. 0123456789 ABCabcXyz
This is internal font 2. 0123456789 ABCabcXyz
This is internal font 3. 0123456789 ABCabcXyz
This is internal font 4. 0123456789 ABCXYZ

```

THIS IS INTERNAL FONT

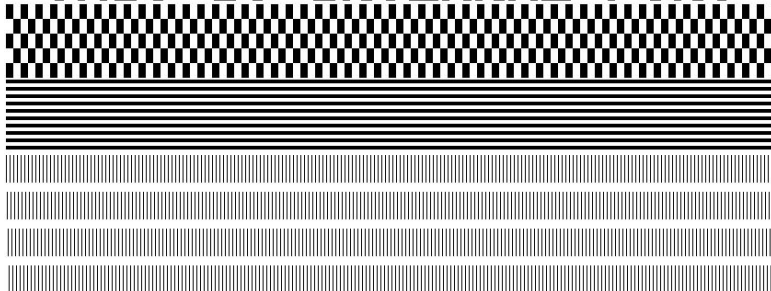

3.3 Restore your printer

By resetting your printer, you can return your printer to the state it was in when you receive it. This can help you solve some problems caused by settings changed during the printing.

Do the following to reset your printer:

1. Turn off the printer.
2. Press and hold the **FEED** button, and turn on the printer.
3. Both status lights glow solid amber for a few seconds. Next, they turn to green shortly, and then turn to other colors. When both lights turn to red, release the **FEED** button immediately.
4. Press and hold the **FEED** button for 3 seconds and release it. Both status lights blink red three times, and turn to solid amber for a few seconds. After restore, LED 2 and LED 1 turns to solid green.



Important In step 4, if you do not hold the **FEED** button long enough, LED 2 will blink amber three times while LED 1 goes out. It means the printer is not reset.

3.4 Communications

3.4.1 Interfaces and Requirements

This printer comes with USB type A and type B interfaces, a nine-pin Electronics Industries Association (EIA) RS-232 serial data interface and an Ethernet module.

■ USB Interface Requirements

The Universal Serial Bus (USB) interface is compatible with your existing PC hardware. The USB’s “plug and play” design makes installation easy. Multiple printers can share a single USB port/hub. The different usage of type A and B as below.

USB type A	USB Flash drive, USB keyboard or USB Scanner.
USB type B	PC to set printer.

■ Serial (RS-232) Port

The required cable must have a nine-pin "D" type male connector on one end, which is plugged into serial port located on the back of the printer. The other end of the cable connects to a serial port on the host computer. For technical and pin-out information, please refer to [RS-232C](#) in this manual.

■ Ethernet Module Status Indicators

The indicators with two different colors help users understand status of Ethernet:

LED Status	Description
Both Off	No Ethernet link detected.
Blinking	The printer waits for printer ready. It will take about few seconds to be ready.

3 Printer operation

Green	Speed LED	On: 100 Mbps link Off: 10 Mbps link
--------------	-----------	--

Amber	Link/Activity LED	On: link up Off: link down Blinking: activity
--------------	-------------------	---

3.5 Driver installation

The bundled printer driver can be applied to all applications under Windows XP/ Vista/ Windows 7/ Windows 8/ Windows 10, supporting 32-bit/ 64-bit operation systems. With this driver you can operate any popular Windows software applications including Argox Bartender UL label editing software or MS Word, etc., to print to this printer.

Drivers can be downloaded from Argox website

3.5.1 Installing a Plug and Play printer driver (for USB only)



Note:

We strongly recommend that you use the Seagull Driver Wizard instead of the Microsoft Windows Add Printer Wizard when installing and updating your Drivers by Seagull.

(Even though the "Add Printer Wizard" is from Microsoft, it too easily performs a number of tasks incorrectly when updating existing drivers. It also badly handles the situation where a printer driver is already in use by a Windows application.)

1. Turn off the printer. Plug the power cable into the power socket on the wall, and then connect the other end of the cable to printer's power socket. Connect the USB cable to the USB port on the printer and on the PC.
2. Turn on the printer. If the printer supports Plug-and-Play, and you have successfully connected it using a USB cable, then the Windows Add Hardware Wizard will automatically detect the printer and display a dialog that allows you to install a driver. Click Cancel and do not install the driver using this wizard.

3 Printer operation

3. Run the driver from Argox website. On the prompt, Windows Printer Driver, select "I accept..." and click "Next".



4. Assign the directory to keep Seagull driver, (for example: C:\Seagull) and click "Next".

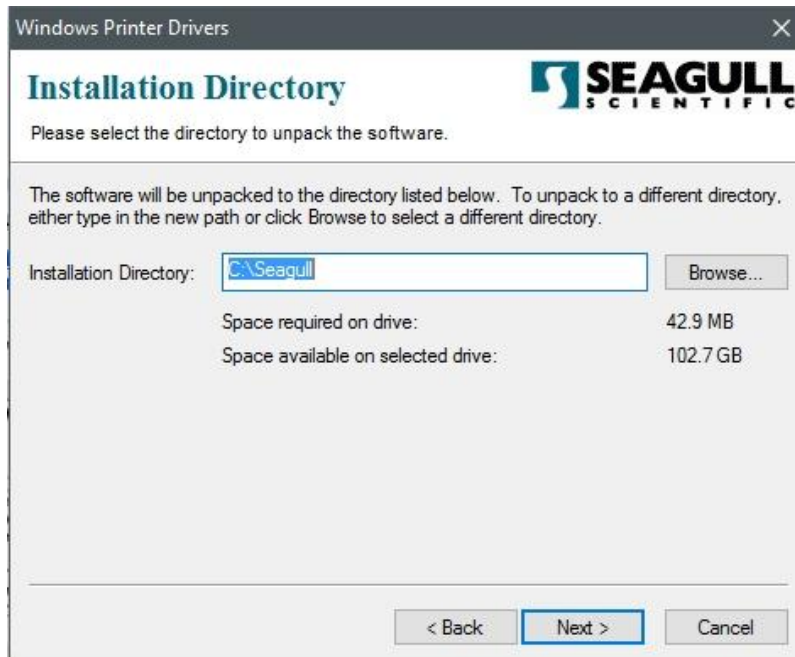

3 Printer operation

5. Click "Finish".

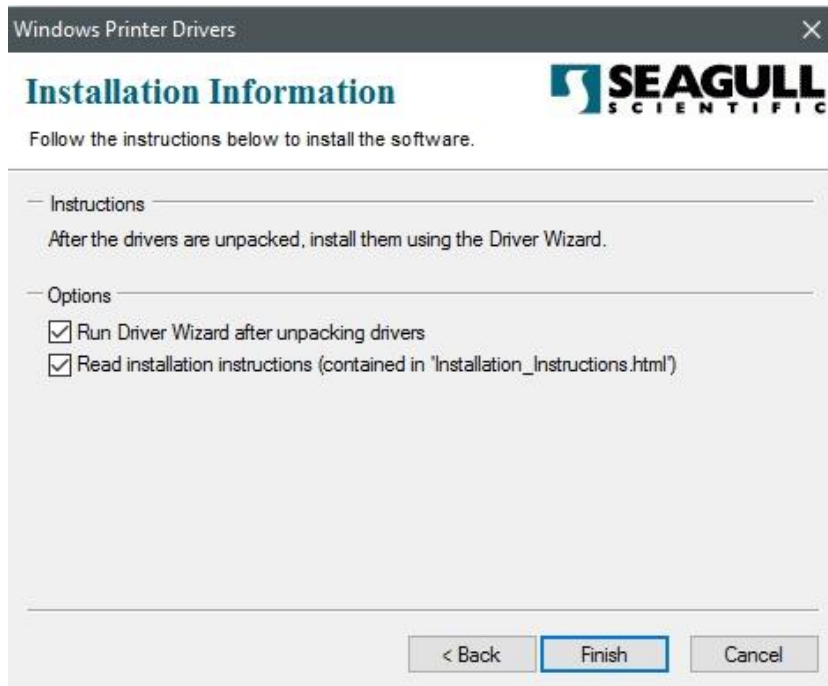

6. Select Install printer drivers and Click "Next"



3 Printer operation

7. On the Seagull Driver Wizard prompt, select the first radio button to “Install a driver for a Plug and Play printer” Then click “Next.”

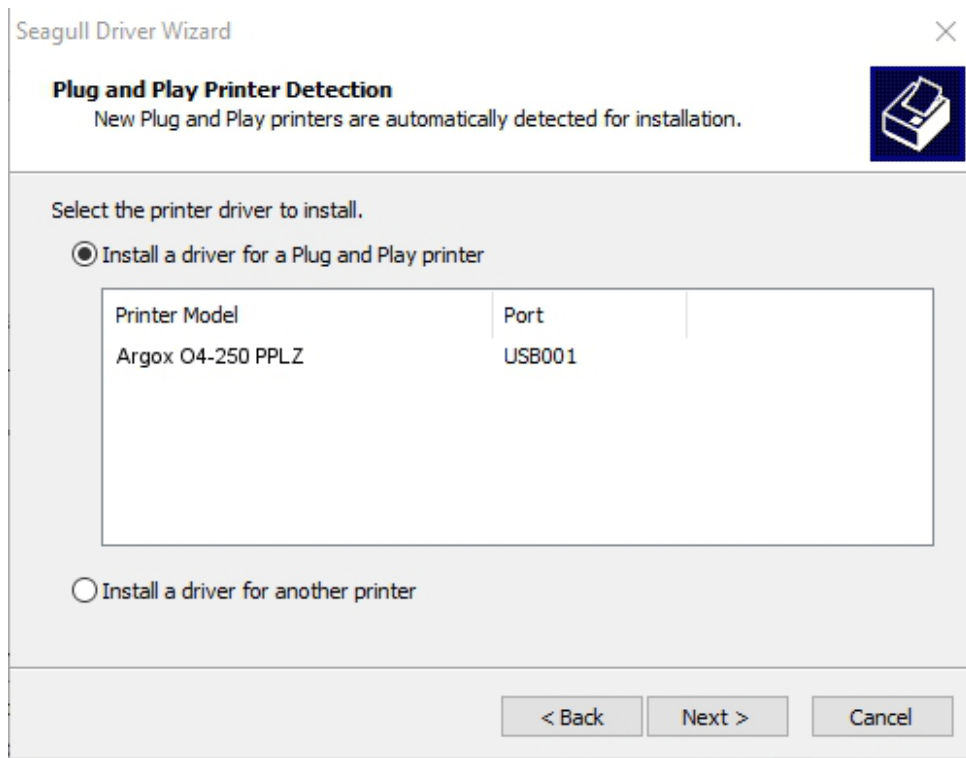

8. Enter Printer name (i.e. Argox O4-250 PPLZ) and select "do not share this printer", and click "Next"

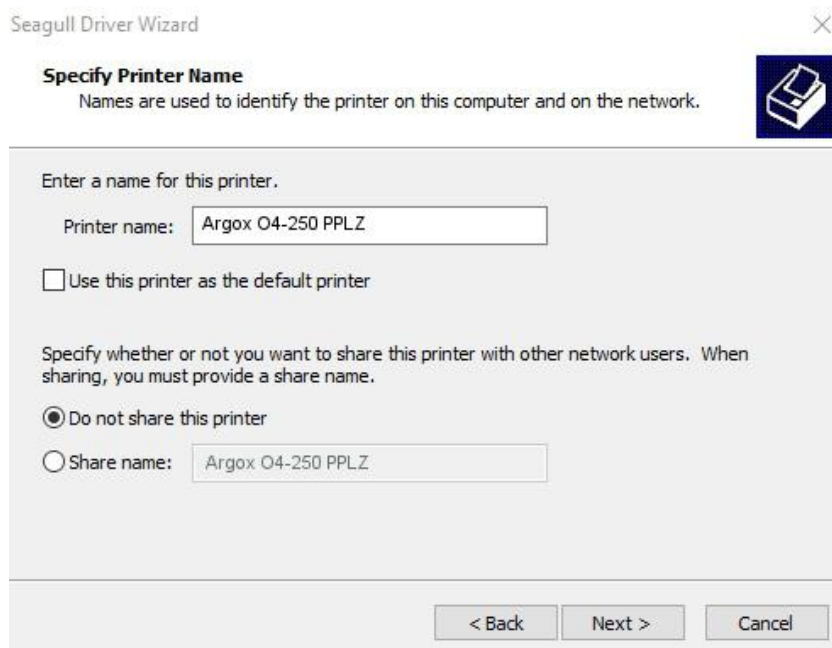

3 Printer operation

9. Check all the data on the showing screen, if it is correct, click "Finish".



10. After the related files have been copied to your system, click "Finish".

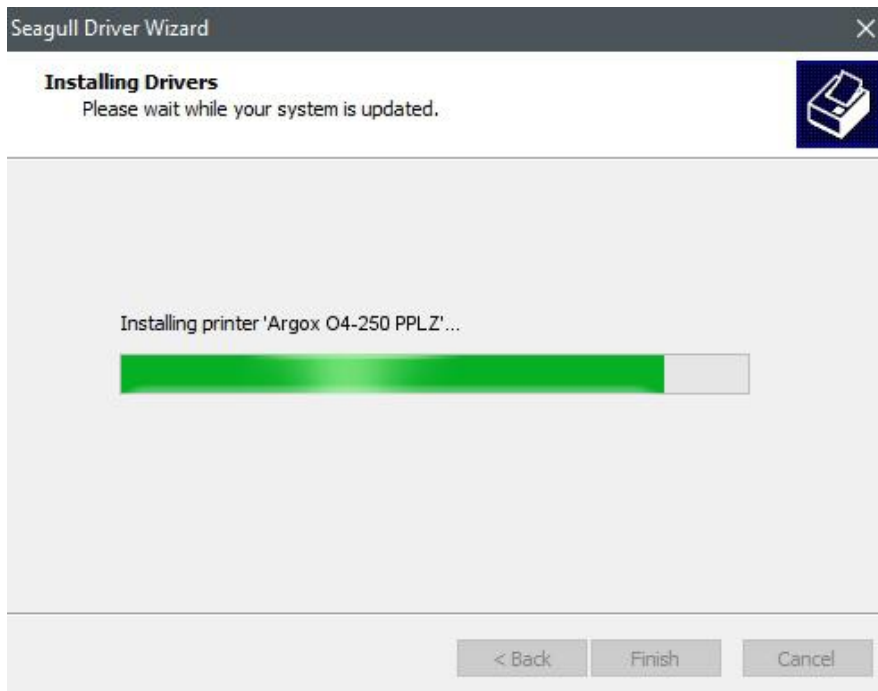

3 Printer operation

11. After driver installation is complete, click "Close". The driver should now be installed.

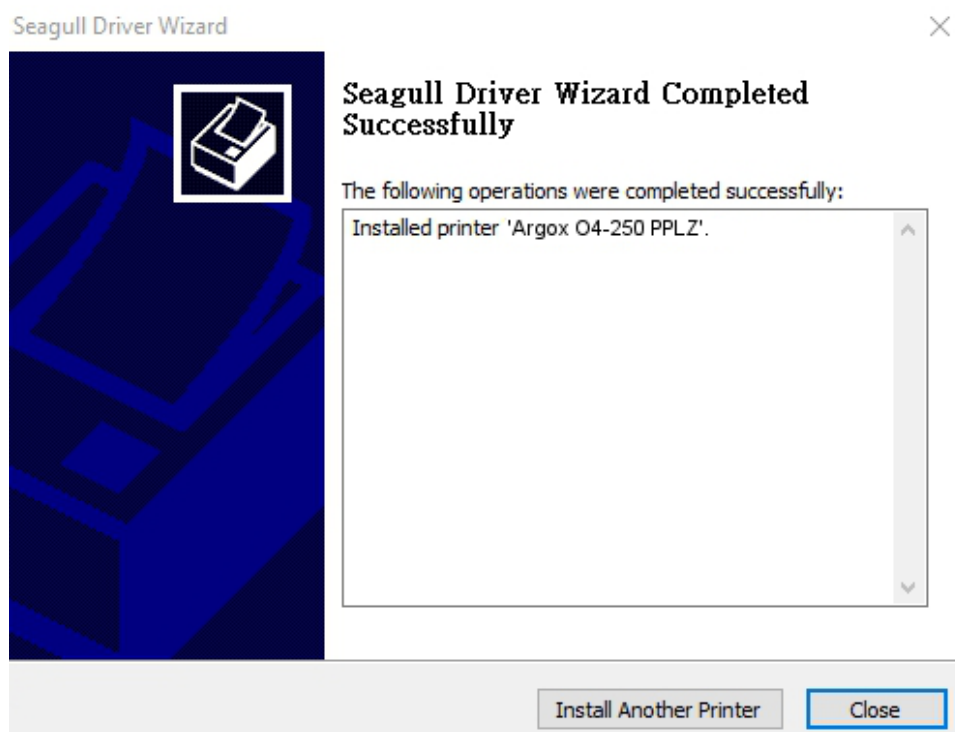

3.5.2 Installing a Printer Driver (for other interfaces except USB)

1. Turn off the printer. Plug the power cable into the power socket on the wall, and then connect the other end of the cable to printer's power socket. Connect the Parallel cable, Serial cable, or Ethernet cable to the proper port on the printer and on your computer.
2. Run the driver from Argox website. On the prompt, Windows Printer Driver, select "I accept..." and click "Next".



3 Printer operation

3. Assign the directory to keep Seagull driver, (for example: C:\Seagull) and click "Next".



4. Click "Finish".



3 Printer operation

5. Select Install printer drivers and Click "Next"



6. Make sure printer is connected to PC, select "Other" and click "Next":

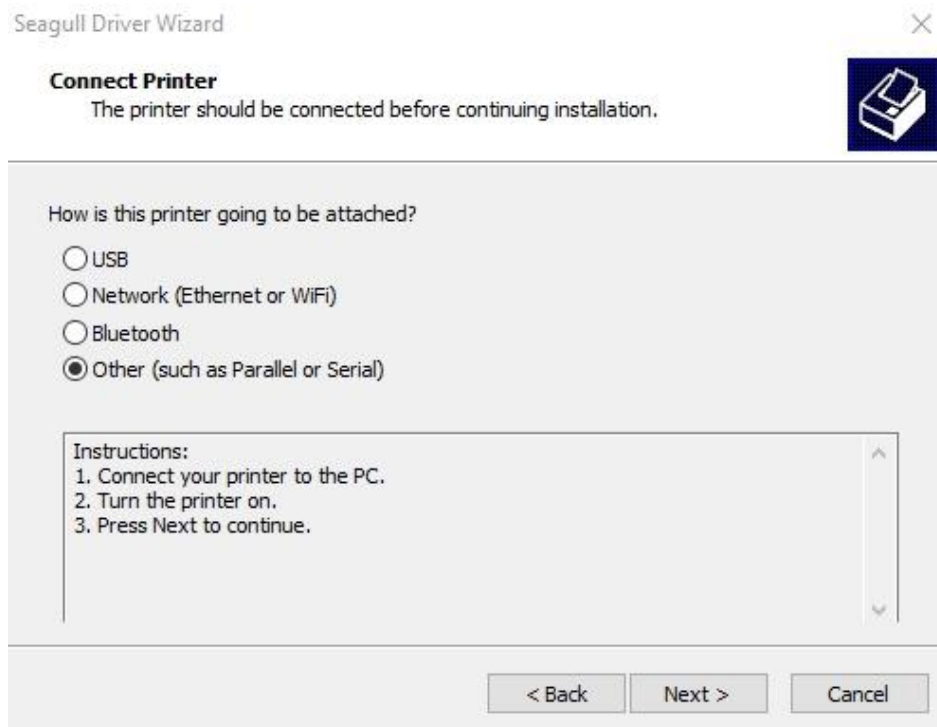

3 Printer operation

7. Select model & emulation - the following examples are based on model O4-250

PPLZ:

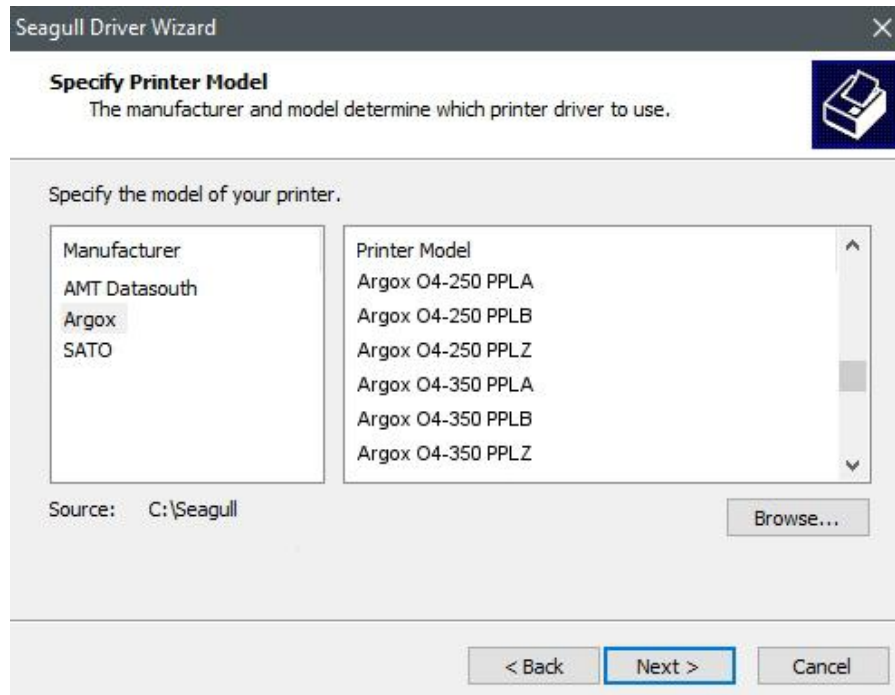

8. Select the port of the printer and click "Next".

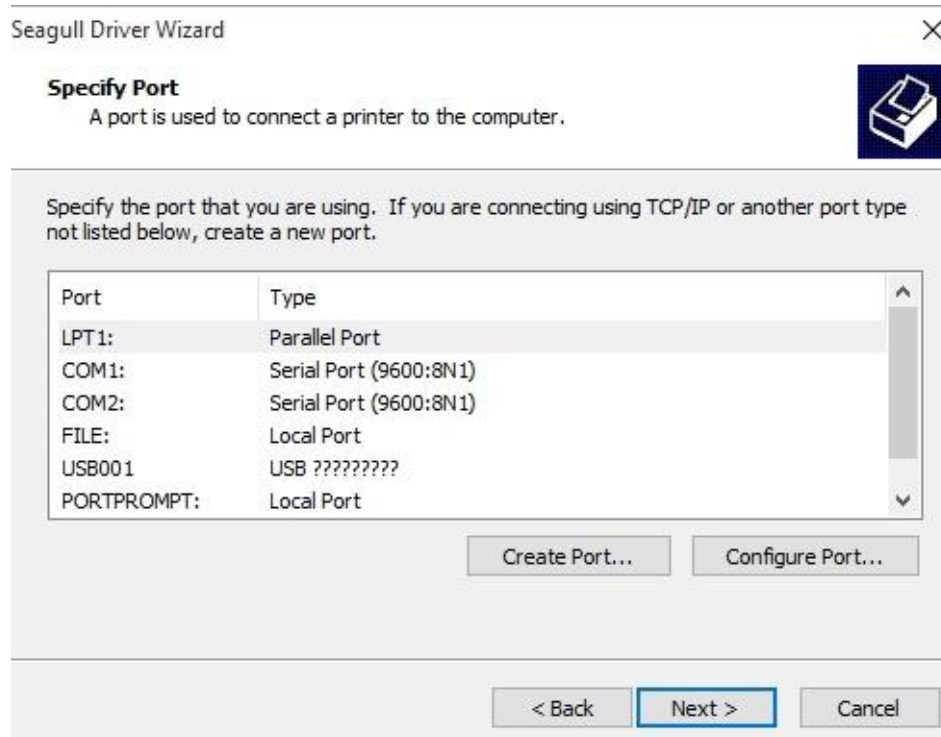

3 Printer operation

9. Enter Printer name (i.e. Argox O4-250 PPLZ) and select "do not share this printer", and click "Next".

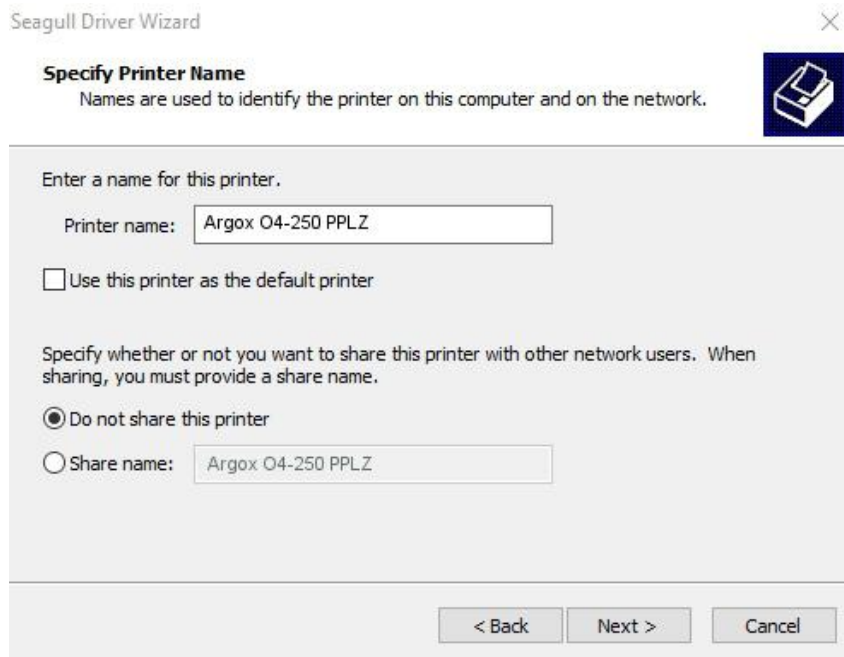

10. Check all the data on the showing screen, if it is correct, click "Finish".

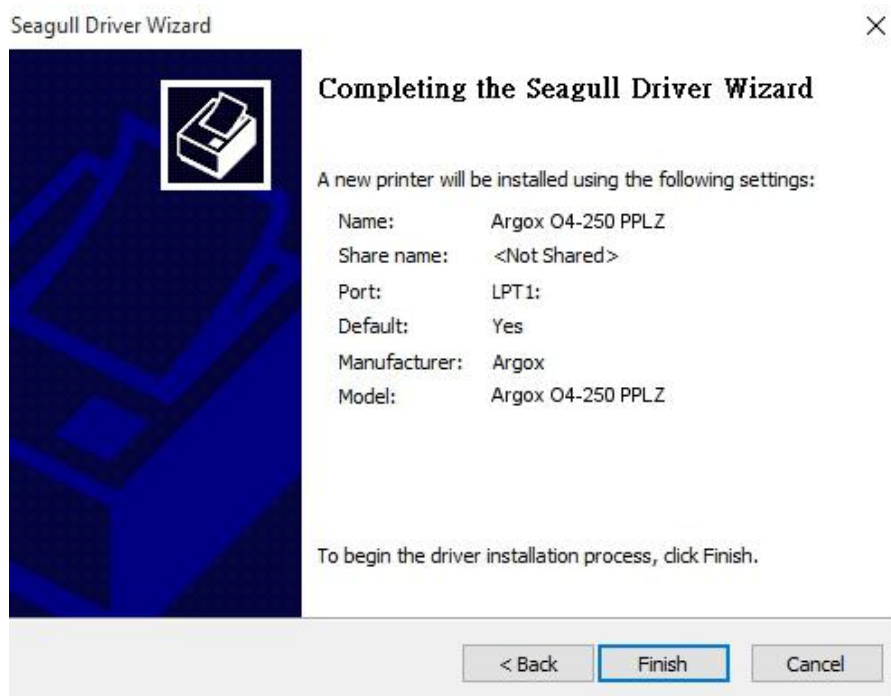

3 Printer operation

11. After the related files have been copied to your system, click "Finish".

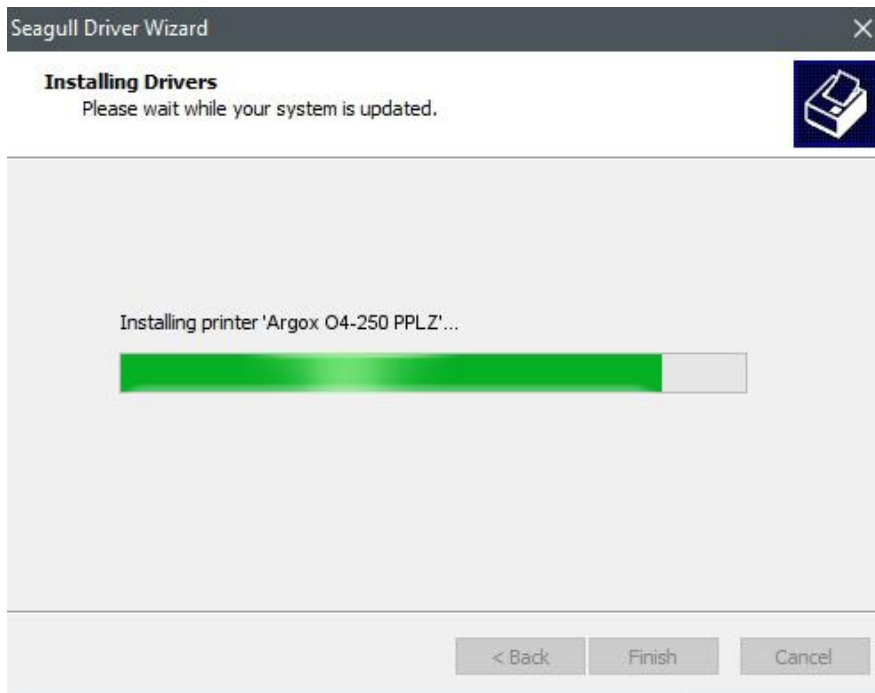

12. After driver installation is complete, click "Close". The driver should now be installed.

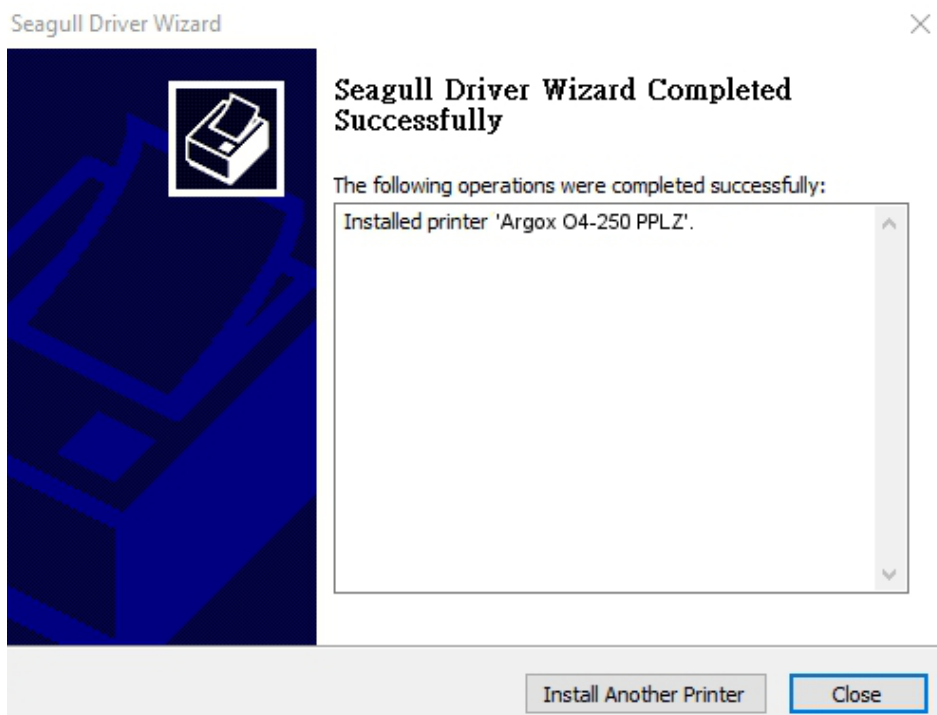

4 Configuration on Web Setting Tool

Before doing settings for your printer, be sure that you have a LAN cable. The cable is connected to the LAN connector of your printer. The LAN connector is an 8-PIN RJ45 type modular connector. Please use the LAN cable of CAT 5 of a proper length to connect the LAN connector on the printer to a LAN hub as appropriate.

The default static IP address of the printer is 0.0.0.0 and the default listen port is 9100. For the first time, to configure your printer through the web setting tool, you must still follow the step-by-step instructions below.

4.1 Attaching the power cord

1. Make sure the printer power switch is set to the **OFF** position.
2. Insert the power supply's connector into the printer power jack.
3. Insert the AC power cord into the power supply.

Important: Use only the power supply listed in the user instructions.

4. Plug the other end of the AC power cord into the wall socket.



Do not plug the AC power cord with wet hands or operate the printer and the power supply in an area where they may get wet. Serious injury may result from these actions!

4.2 Connecting the printer to a LAN hub

Use a LAN cable of CAT 5 of a proper length to connect the LAN connector on the printer to a LAN hub to which your desktop or laptop PC as a host terminal is also connected.

4.3 Getting the IP address of the printer

You can have the printer run a self test to print a configuration label, which helps you get the IP address of your printer connected to the LAN hub.

1. Turn off the printer.
2. Press and hold the **FEED** button, and turn on the printer.
3. Both status lights glow solid amber for a few seconds. Next, they turn to green shortly, and then turn to other colors. When LED 2 turns to green and LED 1 turns to amber, release the **FEED** button.
4. Press the **FEED** button to print a configuration label.
5. Get the IP address of the printer from the printed configuration label.

4.4 Logging in to the web setting tool

The Web Setting Tool is a build-in setting tool in firmware for ARGOX serial printers. User can connect to the supported ARGOX serial printers with browsers to get or set the printer settings, update firmware, download font, etc.

After obtaining the IP address of the LAN printer from the printed configuration label, you can connect to the printer with the supported browsers by input the IP address of the printer, *for example, 192.168.6.185*, in the URL field and connect to it.

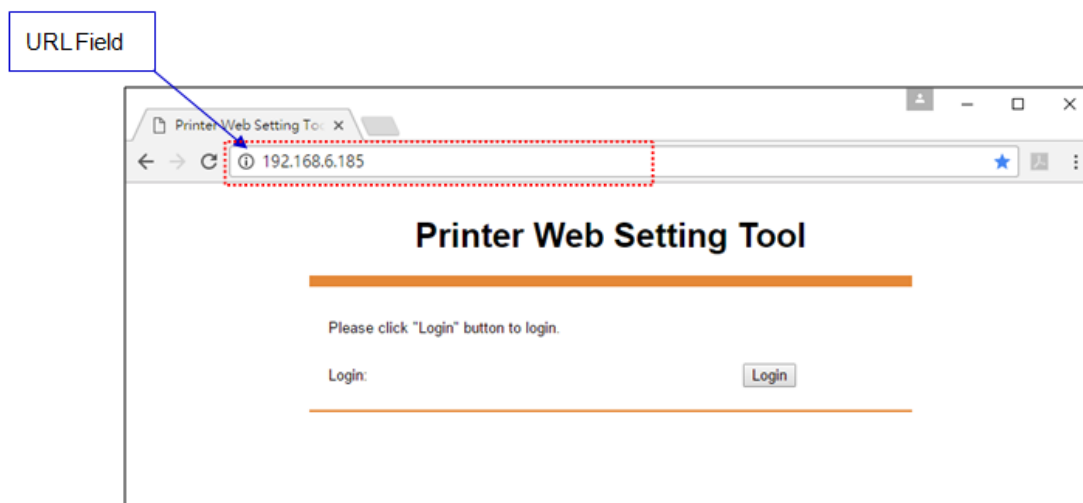

4 Configuration on Web Setting Tool

When the connection is successful, the Login page will be displayed. Input the user name and password to log in to the web setting tool. The default user name and the default password are given below:

Default user name: admin

Default password: admin

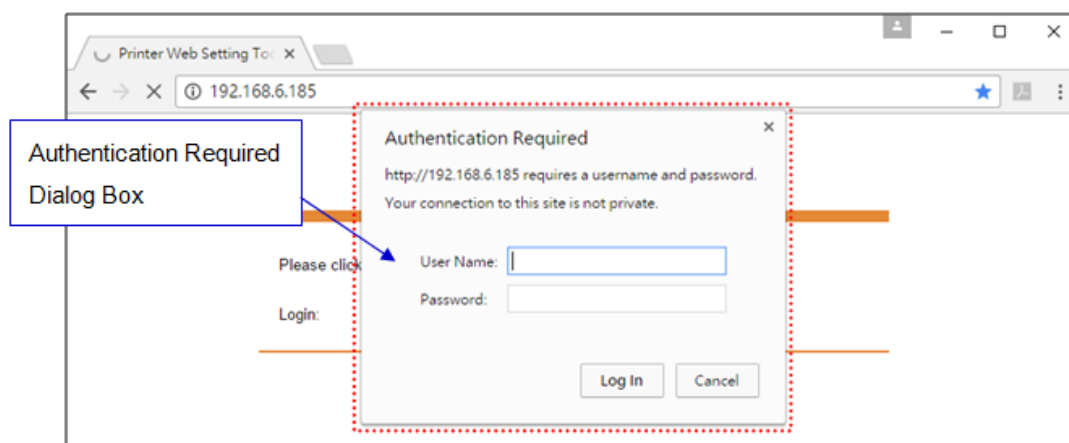

The default password can be changed in the "Device Setting \ Change Login Password" webpage.

This web setting tool can be used to manage multiple label printers in the same local area network segment under the Windows operating system as long as there is no conflicting IP address in the network. You can also check each of the MAC addresses listed in this tool against the MAC address label you can find on each of the printers.

The label printer that is connected through TCP/IP in the way like a directly connected local printer can be used with a random PC connected in the same local area network segment. So, through the tool, all commands applicable to the LAN mode can work on the printer in the same way, as the printer must be configured upon the TCP/IP communication protocol with the IP address of the printer.

When doing settings through a tablet PC or Smart Phone for the printer working in infra mode, please set the same network segment of the host terminal to that of the printer, for example, 192.168.6.XXX (1~254). The Wi-Fi mode for the printer is infra mode that can be searched by the wireless device manager of the host terminal.

5 Maintenance

This chapter describes routine cleaning procedure.

4.1 Cleaning

To maintain print quality and prolong the printer's life, you need to perform some routine maintenance. Daily maintenance should be done for high volume printing, and weekly for low volume printing.



Caution Always turn off the printer before cleaning.

4.1.1 Printhead

It is essential to keep printhead clean if you want the best print quality. We strongly recommend that you clean the printhead when you load a new media roll. If the printer is operated in critical environment, or the print quality declines, you need to clean the printhead more frequently.

Keep in mind these things before you clean:

- Keep the water away in case of corrosion on heating elements.
- If you just finish printing, wait until the printhead cools down.
- Do not touch the printhead with bare hands or hard objects.

Cleaning steps:

1. Moisten a soft cloth or a cotton swab with ethyl alcohol.
2. Gently wipe the printhead in one direction. That is, wipe it only from left to right or vice versa. Do not wipe back-and-forth, in case dust or dirt attaches to the printhead again.

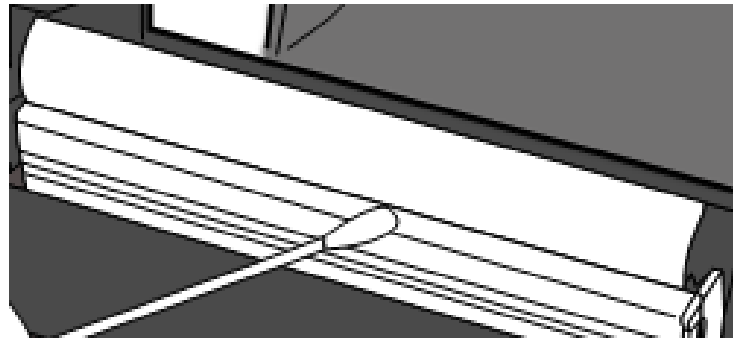

Note Printhead warranty becomes void if printhead's serial number is removed, altered, defected, or made illegible, under every circumstance.

4.1.2 Media housing

Use a soft cloth to clean the dust, dirt or debris built up on the **Media Roll Holders, Media Guides** and media path.

1. Moisten a soft cloth with ethyl alcohol.
2. Wipe the **Media Roll Holders** to clean dust.
3. Wipe the **Media Guides** to clean dust and dirt.
4. Wipe the media path to clean paper debris.

4.1.3 Sensor

Media sensors may not be able to detect the media correctly if it becomes dirty.

1. Moisten a soft cloth or a cotton swab with absolute ethyl alcohol.
2. Gently brush sensors to remove the dust away.
3. Use a dry cloth to clean the residue.

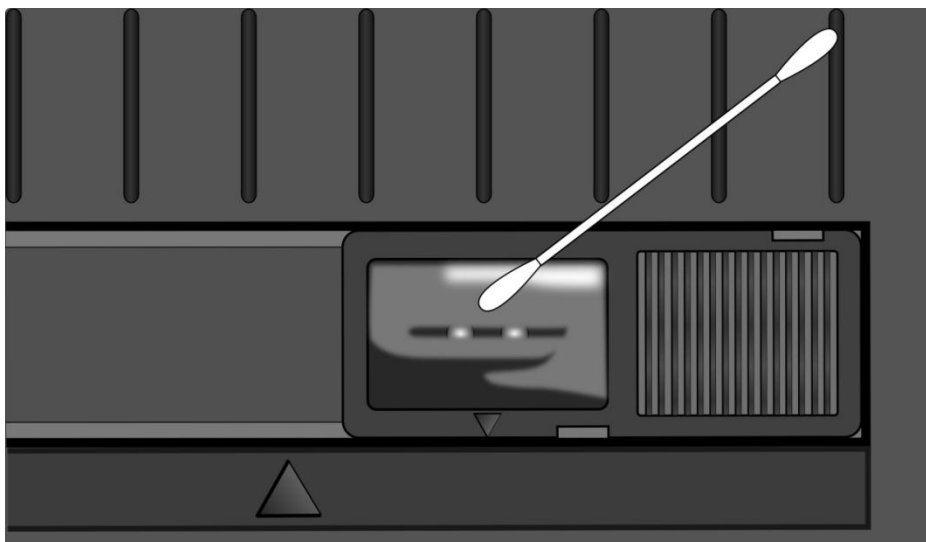

4.1.4 Platen roller

The platen roller is also important for print quality. Dirty platen roller may damage the printhead. Clean the platen roller right away if the adhesive, dirt or dust accumulates on it.

1. Moisten a soft cloth with absolute ethyl alcohol.
2. Gently wipe the platen roller to remove the dust and adhesive.

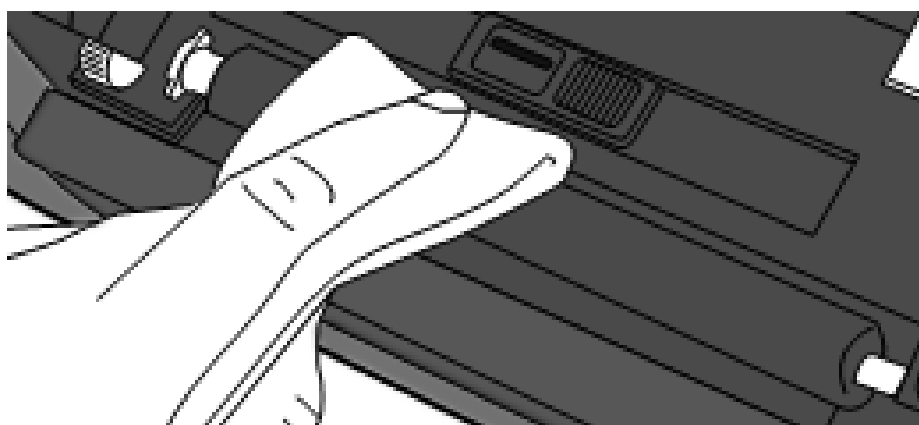

6 Troubleshooting

This chapter provides the information about printer problems and solutions.

5.1 Printer issues

The printer is not turned on

- Did you attach the AC power cord?
- Make sure the power supply's connector is inserted into the printer power jack.
- Check the power connection from the wall socket to the printer. Test the power cord and the socket with other electrical devices.
- Disconnect the printer from the wall socket, and connect it again.

The printer turns itself off

- Turn on the printer again.
- Make sure the power supply's connector and the power cord are plugged properly.
- Make sure the power supply and the power cord are not damaged.
- Use the applicable power supply.
- If the printer keeps turning itself off, check the socket and make sure it has enough power for the printer.

The printer does not feed the media out

- The media is not loaded correctly. See Section 2.3, "[Load Media](#)" to reload the media.
- If there is a paper jam, clear it.

5.2 Media issues

The media is out

- Load a new media roll.

The paper is jammed

- Open the printer and clear the jammed paper.
- Make sure the paper is held properly by the **Media Guides**.

The printing position is not correct

- Did you use the correct media type for printing?
- The media is not loaded correctly. See Section 2.3, "[Load Media](#)" to reload the media.
- The media sensor needs to be calibrated. See Section 3.1, "[Printing Media Calibration & Configuration](#)" to calibrate the sensor.
- The media sensor is dirty. Clean the media sensor.

Nothing is printed

- The media is not loaded correctly. See Section 2.3, "[Load Media](#)" to reload the media.
- The ribbon is not loaded correctly. See Section 2.5, "[Placing Ribbon Roll](#)" to reload the ribbon.
- The print data might not be sent successfully. Make sure the interface is set correctly in the printer driver, and send the print data again.

The print quality is poor

- The printhead is dirty. Clean the printhead.
- The platen roller is dirty. Clean the platen roller.
- Adjust the print darkness, or lower the print speed.
- The media is incompatible for the ribbon. Use the compatible media instead.

5.3 Ribbon Problems

The ribbon is out

- Load a new ribbon roll.

The ribbon is broken

- Check the print darkness and adjust it if it is too high, and take the following steps to fix the broken ribbon:
 1. Unload the ribbon supply roll and take-up roll from the printer.
 2. Pull the ribbon from the supply roll so it overlaps the broken end of the take-up roll.
 3. Tape the overlapped parts together.
 4. Reload both rolls into the printer.

The ribbon is “printed out” with the media

- The ribbon is not loaded correctly. See Section 2.5, “[Placing Ribbon Roll](#)” to reload the ribbon.
- The printhead temperature is too high. Reload the ribbon and print a configuration label to check the settings (see Section 3.2, “[Self Test](#)”). If the print darkness is very high, adjust it in printer preference, or reset your printer (see Section 3.3, “[Restore Your Printer](#)”).

The ribbon is wrinkled

1. Make sure the ribbon is loaded correctly.
2. Rotate the **Take-Up Wheel** to straighten the ribbon.

5.4 Other issues

There are broken lines in the printed label

- The ribbon is wrinkled. Adjust or reload the ribbon. Or, print a few labels until the wrinkled part goes away.
- The printhead is dirty. Clean the printhead.

An error occurred when writing data to the USB memory

- Did you insert the USB drive?
- Make sure the USB drive is plugged tightly into the port.
- The USB drive might be broken. Replace it with another one.

The printer is unable to save files due to insufficient USB memory

- Delete the files on your USB drive to free some space, or replace your USB drive with an empty one.

The cutter is experiencing issues

- If there is a paper jam, clear it.
- The cutter has become loose. Fix the cutter in position and tighten it.
- The cutter blade is not sharp anymore. Replace your cutter with a new one.

The printhead temperature is extremely high

- The printhead temperature is controlled by the printer. If it is extremely high, the printer will stop printing automatically, until the printhead is cool down. After that, the printer will resume printing automatically, if there is any unfinished print job.

The printhead is broken

- Contact your local dealer for assistance.

7 Specifications

This chapter provides specifications for the printer. Specifications are subject to change without notice.

6.1 Printer

Model	O4-250	O4-350
Print method	Direct Thermal and Thermal Transfer	
Resolution	203 dpi (8 dots/mm)	300 dpi (12 dots/mm)
Media Alignment	Centered	
Operation Mode	Standard: Continuous mode , Tear-off mode Optional: Cutter mode , Peeler mode	
Sensor	Media Transmissive Sensor (Fixed)	
	Reflective Sensor (Movable)	
	Head Open Switch	
Operation interface	LED indicator x 2, Button x 1	
	Option: LCD display	
Print Speed	2, 3, 4, 5, 6, 7 inches/sec (50.8, 76.2, 101.6, 127, 152.4, 177.8 mm/sec)	2, 3, 4, 5, 6 inches/sec (50.8, 76.2, 101.6, 127, 152.4 mm/sec)
	2 & 3ips for peel off mode	2 & 3ips for peel off mode
Printable Area	Max. length 100"	Max. length 50"
Print Ratio	Average print ratio within 15 % or less (whole print layout area) Full width with 1mm pitch is required	
Interface	RS-232 ,Dual USB hosts(Type A), USB device(Type B), Ethernet Optional: Wi-Fi(IEEE 802.11b/g/n), Bluetooth V4.2, RTC, Buzzer	
Programming Language	PPLA+PPLB+PPLZ	
Accessories	Peeler, Full Cutter, Partial Cutter, External Media Stand	
On-Board Memory	Standard Memory (Flash ROM): 16 MB User Memory: 8 MB	

7 Specifications

	Standard Memory (SDRAM): 32 MB
	USB storage up to 32 GB (FAT32 format only)
CPU Type	32 bit RISC microprocessor
Software---Label editing	Windows Driver (Windows XP/Vista/ Win 7/ Win 8/ Win 10), BarTender® from Seagull Scientific
Software--- Utility	Printer Tool
Agency Listing	CB, CE, FCC, TUV/cTUVus, Energy Star, RoHS, BSMI



Note Print quality and speed is based on 15% print coverage.

6.2 Media

Properties	Description				
Media Size	Max. width: 4.645" (118mm).				
	Min. width: 0.787" (20 mm).				
	Thickness: 0.00236"~0.00787" (0.06mm~0.2mm)				
	Core size:	<table border="1"> <tr> <td>0.5"</td> <td>1"</td> <td>1.5"</td> </tr> </table>	0.5"	1"	1.5"
	0.5"	1"	1.5"		
	Media roll capacity OD:	<table border="1"> <tr> <td>4.5"</td> <td>5"</td> </tr> </table>	4.5"	5"	
4.5"	5"				
Min. width for partial cutter options. Min. length)for cutter options.					
Media Type	Thermal Transfer Label Thermal Transfer Tag Direct Thermal Label Direct Thermal Tag Roll Paper (Inside Wound or Outside Wound) Fanfold Paper				
Ribbon Size	Width: 1 inch ~ 4.33 inch (25.4~110 mm)(core length 110mm w/ notch) Length: 110 m (φ Core Size: 0.5 inch)				
Ribbon Type	Wax, Wax-Resin, Resin Coated Side In or Coated Side Out				

6.3 Electrical and operating environment

Properties	Range
Power Supply	Voltage: AC 100 V ~ 240 V \pm 10 % (full range) Frequency: 50 Hz - 60 Hz \pm 5 %
Temperature	Operating: 41°F~104°F(5 °C ~ 40 °C) Storage: -4°F~140°F(-20 °C ~ 60 °C)
Humidity	Operating: 25 %RH ~ 85 %RH (non-condensing) Storage: 10 %RH ~ 90 %RH (non-condensing)

6.4 Physical dimension

Dimension	Size and Weight
Size	W 209 mm x H 179 mm x D 266 mm
Weight	2.14 kg (excluding media and accessories)

6.5 Fonts, Barcodes, and Graphics Specification

The specifications of fonts, bar codes and graphics depends on the printer emulation. The emulations PPLA, PPLB, and PPLZ are printer programming languages, through which the host can communicate with your printer.

Printer Programming Language PPLA

Programming Language	PPLA
Internal fonts	9 fonts with different point size 6 fonts with ASD smooth font. Courier font with different symbol sets.
Symbol sets (Code pages)	Courier font symbol set: Roman-8, ECMA-94, PC, PC-A, PC-B, Legal, and PC437 (Greek), Russian.
Soft fonts	Downloadable soft fonts by Print Tool
Font size	1x1 to 24x24 times
Character rotation	0, 90, 180, 270 degree, 4 direction rotation
Graphics	PCX, BMP, IMG, GDI and HEX format files
1D Barcodes	Code 39、UPC-A、UPC-E、Code 128 subset A/B/C、EAN-13、EAN-8、HBIC、Codabar、Plessey、UPC2、UPC5、Code 93、Postnet、UCC/EAN-128、, UCC/EAN-128 K-MART、UCC/EAN-128 Random weight、Telepen、FIM、Interleaved 2 of 5 (Standard/with modulo 10 checksum/ with human readable check digit/ with modulo 10 checksum & shipping bearer bars) 、GS1 Data bar (RSS)
2D Barcodes	MaxiCode、PDF417、Data Matrix (ECC 200 only) 、QR code、Composite Codes、Aztec

Printer Programming Language PPLB

Programming Language	PPLB
Internal fonts	5 fonts with different point size
Symbol sets (Code pages)	8 bits code page : 437, 850, 852, 860, 863, 865, 857, 861, 862, 855, 866, 737, 851, 869, 1252, 1250, 1251, 1253, 1254, 1255 7 bits code page: USA, BRITISH, GERMAN, FRENCH, DANISH, ITALIAN, SPANISH, SWEDISH and SWISS
Soft fonts	Downloadable soft fonts by Print Tool
Font size	1x1 to 24x24 times
Character rotation	0, 90, 180, 270 degree, 4 direction rotation
Graphics	PCX , Binary Raster, BMP and GDI
1D Barcodes	Code 39、UPC-A、UPC-E、Matrix 2 of 5、UPC-Interleaved 2 of 5、 Code 39 with check sum digit 、Code 93、EAN-13、EAN-8 (Standard, 2 /5digit add-on) 、Codabar、Postnet、Code128 subset A/B/C、 Code 128 UCC (shipping container code) 、 Code 128 auto、UCC/EAN code 128 (GS1-128) 、Interleave 2 of 5、Interleaved 2 of 5 with check sum、Interleaved 2 of 5 with human readable check digit、German Postcode、Matrix 2 of 5、UPC Interleaved 2 of 5、EAN-13 2/5 digit add-on、UPCA 2/5 digit add-on、UPCE 2/5 digit add-on、 GS1 Data bar (RSS)
2D Barcodes	MaxiCode、PDF417、Data Matrix (ECC 200 only) 、QR code、 Composite Codes、Aztec

Printer Programming Language PPLZ

Programming Language	PPLZ
Internal fonts	8 (A~H) fonts with different point size. 8 AGFA fonts: 7 (P~V) fonts with fixed different point size (not scalable). 1 (O) font with scaling point size.
Symbol sets (Code pages)	USA1, USA2, UK, HOLLAND, DENMARK/NORWAY, SWEDEN/FINLAND, GERMAN, FRANCE1, FRANCE2, ITALY, SPAIN, MISC, JAPAN, IBM850, Multibyte Asian Encodings, UTF-8, UTF-16 Big-Endian, UTF-16 Little-Endian, Code page 1250, 1251, ,1252, 1253, 1254
Soft fonts	Downloadable soft fonts by Print Tool
Font size	1x1 to 10x10
Character rotation	0, 90, 180, 270 degree, 4 direction rotation
Graphics	GRF, Hex and GDI
1D Barcodes	Code39、UPC-A、UPC-E、Postnet、Code128 subset A/B/C、 Interleave 2 of 5、 Interleaved 2 of 5 with check sum、 Interleaved 2 of 5 with human readable check digit、Code 93、Code 39 with check sum digit、 MSI、EAN-8、Codabar、Code 11、EAN-13、Plessey、GS1 Data bar (RSS) 、Industrial 2 of 5、Standard 2 of 5、Logmars
2D Barcodes	MaxiCode、PDF417、Data Matrix (ECC 200 only) 、QR code、 Composite Codes、Aztec

6.6 Ethernet

Properties	Description
Port	RJ-45
Speed	10Base-T/100Base-T (Auto Detecting)
Protocol	ARP, IP, ICMP, UDP, TCP, HTTP, DHCP, Socket, LPR, IPv4, IPv6, SNMPv2
Mode	TCP Server/Client, UDP Client
Technology	HP Auto-MDIX, Auto-Negotiation

6.7 Bluetooth (Option)

Properties	Bluetooth I/F
Standard	Bluetooth 4.2
Enable Device	BT PRINTER
Operating Temperature	41°F (5°C) ~ 104°F (40°C)
Storage Temperature	-4°F (-20°C) ~ 140°F (60°C)
Operating Humidity	25 ~ 85 % Non-condensing R.H
Storage Humidity	10 ~ 90 % Non-condensing R.H
Connection Form	Only one-to-one connection is supported.
Support Profile	Serial Port Profile (SPP) PIN code is supported.
Class of Radio Transmission	CLASS 2
Transmission Method	Bi-directional (Half-duplex)
Flow Control	Credit based flow control
Operating Mode	Slave Mode
Transmission Distance	10 m (360 degrees)
SR Mode in Page/Inquiry Scanning	R1 Scan Interval 1.28 sec. Scan Window 22.5 msec.
RF Frequency Range	2402 ~ 2480 MHz
Nominal Output Power	+4 dBm (2.51 mW) MAX
Communications	Support BT 4.2 on Android connectivity

6.8 Wireless LAN (Option)

Properties		Wireless LAN I/F				
Hardware	Protocol	IEEE 802.11 b/g/n				
	Enabled Device	WIRELESS PRINTER				
	Operating Temperature	-20°C ~ +85°C				
	Destination	USA	Europe			
	Frequency (Center Channel)	2412 ~ 2462 MHz	2412 ~ 2472 MHz			
	Channel	1 ~ 11 ch	1 ~ 13 ch			
	Spacing	5 MHz				
	Transmission Speed/Modulation	IEEE 802.11b	Transmission Method	Conforming to IEEE 802.11b DSSS method		
			Channel	Depending on the country		
			Data Transmission Speed/Modulation	11/5.5 Mbps: CCK 2 Mbps: DQPSK 1 Mbps: DBPSK		
			IEEE 802.11g	Transmission Method	Conforming to IEEE 802.11g OFDM method DSSS method	
				Channel	Depending on the country	
				Data Transmission Speed/Modulation	54/48 Mbps: 64 QAM 36/24 Mbps: 16 QAM 18/12 Mbps: QPSK 9/6 Mbps: BPSK	
IEEE 802.11n		Transmission Method	Conforming to IEEE802.11n OFDM method			
		Channel	(US)1-11ch (JP/DE)1-13ch			
		Data Transmission Speed/Modulation	20MHz : 6.5M / 7.2M / 13M / 14.4M / 19.5M / 21.7M / 26M / 28.9M / 39M / 43.3M / 52M / 57.8M / 58.5M / 65M /			

Properties		Wireless LAN I/F		
		72.2M(Auto-sensing)		
Antenna	External antenna			
Aerial power	802.11b	Max +15 dBm		
	802.11g	Max +17 dBm		
	802.11n	Max +17 dBm		
Software	Connection mode	Infrastructure, Adhoc		
	Default IP Address	192.168.1.1		
	Default Subnet Mask	255.255.0.0		
	Default ESSID	WIRELESS PRINTER		
	Security	IEEE 802.11i		
		Cryptography	WEP 128 bit, TKIP (WPA), AES (WPA2)	
		Authorization	Open Key (for WEP), PSK	
	Protocol (*)	TCP/IP, Socket, DHCP		
	Wireless LAN Parameter Setting and Status Monitor	Parameter Setting: Command (PC Setting Tool)		

6.9 Interfaces

This section provides information about IO port specifications for the printer.

6.9.1 USB

There are two common USB connectors. Typically, type A is found on hosts and hubs; type B is found on devices and hubs. The figure below shows their pinouts.



7 Specifications

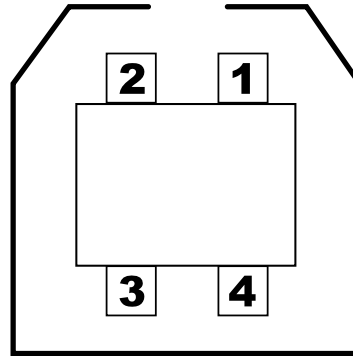
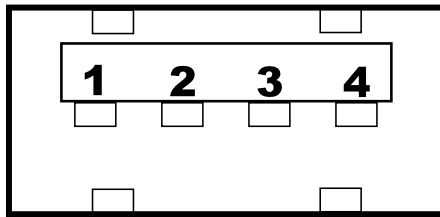

Pin	Signal	Description
1	VBUS	+5V
2	D-	Differential data signaling pair -
3	D+	Differential data signaling pair +
4	Ground	Ground

6.9.2 Ethernet

The Ethernet uses RJ-45 cable, which is 8P8C (8-Position 8-Contact). The figure below shows its pinout.

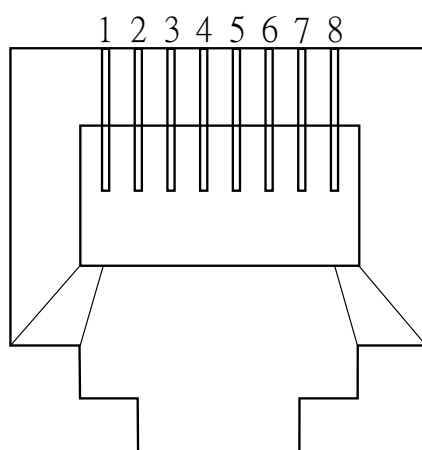

Pin	Signal
1	Transmit+
2	Transmit-
3	Receive+
4	Reserved
5	Reserved
6	Receive-
7	Reserved
8	Reserved

6.9.3 RS-232C

The RS-232C on the printer is DB9 female. It transmits data bit by bit in asynchronous start-stop mode. The figure below shows pinouts.

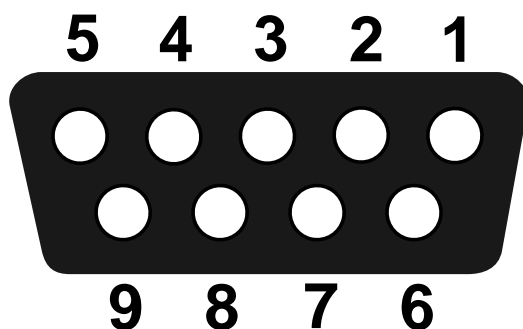

Pin	Signal	Description
1	NA	No Function
2	TxD	Transmit
3	RxD	Receive
4	NA	No Function
5	GND	Ground
6	NA	No Function
7	CTS	Clear to Send
8	RTS	Request to Send
9	NC	No Connection

Host (DB9)			Printer (DB9)		
Signal	Description	Pin	Pin	Description	Signal
CD	Carrier Detect	1	1	No Function	NC
RxD	Receive	2	2	Transmit	RxD
TxD	Transmit	3	3	Receive	TxD
DTR	Data Terminal Ready	4	4	No Function	NC
GND	Ground	5	5	Ground	GND
DSR	Data Set Ready	6	6	No Function	NC
RTS	Request to Send	7	7	Clear to Send	RTS
CTS	Clear to Send	8	8	Request to Send	CTS
CI		9	9	No Function	NC